

# Operating Instructions

## Datascope Passport® 2

## Datascope Passport® 2LT



**mindray**<sup>™</sup>  
NORTH AMERICA

Operating Instructions

Datascope  
**Passport<sup>®</sup> 2**

Datascope  
**Passport<sup>®</sup> 2LT**

---

*CapnoLine™ and NIV Line™ are trademarks of Oridion Medical Ltd.*

*DRYLINE™ is a trademark of Artema Medical AB*

*Masimo SET®, LNCS®, and LNOP® are U.S. registered trademarks of Masimo Corporation.*

*MediCO<sub>2</sub>® is a registered trademark of Oridion Medical Ltd.*

*Microstream® and FilterLine® are U.S. registered trademarks of Oridion Medical Ltd.*

*Navigator™, Auto-Set™, and View 12™ are U.S. trademarks of Mindray DS USA, Inc.,*

*Nellcor®, Oxismart®, Oxiband®, and Durasensor® are U.S. registered trademarks of Nellcor Puritan Bennett Inc.*

*OxiMax® and Max-Fast® are U.S. registered trademarks of Nellcor Puritan Bennett Inc.*

*Oxisensor® is a U.S. registered trademark of Nellcor Puritan Bennett Inc.*

*Panorama™ is a U.S. trademark of Mindray DS USA, Inc.,*

*Passport 2® is a U.S. registered trademark of Mindray DS USA, Inc.,*

*PatientNet® is a U.S. registered trademark of GE Medical Systems Information Technologies.*

*Velcro® is a registered trademark of Velcro Industries B.V.*

*Copyright© Mindray DS USA, Inc., 2005. All rights reserved. Contents of this publication may not be reproduced in any form without permission of Mindray DS USA, Inc.,*

Foreword .....	vii
Warnings, Precautions And Notes .....	vii
Warnings .....	viii
Precautions .....	xii
Notes .....	xv
Intended Use .....	xvi
Unpacking .....	xvi
Symbols and Descriptions .....	xvii
<b>General Description .....</b>	<b>1 - 1</b>
<b>Controls, Indicators and Connectors .....</b>	<b>2 - 1</b>
Front Panel .....	2 - 2
Display .....	2 - 6
Menus .....	2 - 9
Patient .....	2 - 9
Monitor Setup .....	2 - 11
Print Setup .....	2 - 14
Parameters .....	2 - 15
Functions Menu .....	2 - 16
Left Side Panel .....	2 - 17
Right Side Panel .....	2 - 19
Rear Panel .....	2 - 20
Remote Color Display (Passport 2 Only) .....	2 - 21
Gas Module (Optional Passport 2) .....	2 - 22
Gas Module II and SE .....	2 - 22
Front Panel .....	2 - 22
Rear Panel .....	2 - 23
Gas Module 3 .....	2 - 24
Front Panel .....	2 - 24
Rear Panel .....	2 - 25
Comm-Port (Optional Passport 2) .....	2 - 26
<b>Operation .....</b>	<b>3 - 1</b>
Getting Started .....	3 - 1
Installation Mode .....	3 - 3
Installation Menu .....	3 - 3
System Information Menu .....	3 - 6
Non-Invasive Blood Pressure Measurements (NIBP) .....	3 - 8
The NIBP Menu .....	3 - 8
Manual NIBP Measurements .....	3 - 8
Automatic NIBP Measurements .....	3 - 10
Automatic Adjustment in the Interval Mode .....	3 - 10
Suspension of NIBP Measurements .....	3 - 11
NIBP Pressure Limit Fail Safe .....	3 - 11
Cuff Inflation Time .....	3 - 11
START and STOP Functions .....	3 - 11
NIBP Auto Time Out Functions .....	3 - 12
ECG Measurements .....	3 - 13
Electrocardiogram (ECG) Monitoring .....	3 - 13
Skin Preparation .....	3 - 13
Electrode Patch Location .....	3 - 14
Lead Placement .....	3 - 14
The ECG Menu .....	3 - 22
3 Lead or 5 Lead ECG Measurements .....	3 - 23

"ECG Lead Fault" Message .....	3 - 24
12-Lead ECG Monitoring (Optional Passport 2).....	3 - 24
12-lead ECG Analysis (Optional Passport 2) .....	3 - 25
Invasive Blood Pressure (IBP1, IBP2) (optional Passport 2) .....	3 - 26
SpO <sub>2</sub> Pulse Oximetry .....	3 - 27
SpO <sub>2</sub> Menu .....	3 - 27
SpO <sub>2</sub> Measurements.....	3 - 27
Performance Considerations .....	3 - 29
Calibration .....	3 - 29
Auto Scaling .....	3 - 29
Masimo <sup>®</sup> Sensors and Patient Cable.....	3 - 29
Masimo Sensors and Accessories .....	3 - 30
Selecting a Sensor .....	3 - 30
Cleaning and Re-use .....	3 - 31
Nellcor <sup>®</sup> Sensors and Patient Cable.....	3 - 31
Selecting a Sensor .....	3 - 31
Cleaning and Re-Use .....	3 - 31
ST Monitoring (Optional Passport 2).....	3 - 32
ST Setup.....	3 - 33
Arrhythmia Algorithm (Optional Passport 2) .....	3 - 34
ST Segment Analysis (Optional Passport 2) .....	3 - 37
Arrhythmia Alarms (Optional Passport 2) .....	3 - 38
Lethal Arrhythmia Alarms.....	3 - 38
Non-Lethal Arrhythmia Alarms.....	3 - 39
Arrhythmia Analysis (Optional Passport 2) .....	3 - 42
Temperature Menu .....	3 - 44
List Trends (Passport 2 Only).....	3 - 45
Modification of Parameters Displayed .....	3 - 46
Modification of Trend Entry Conditions.....	3 - 46
Filtering of List Trend Data Displayed .....	3 - 46
Printing List Trend Data.....	3 - 47
Transferring List Trend Data Between Different Passport 2 Monitors .....	3 - 47
Transfer Notes.....	3 - 47
Clearing Trend Data .....	3 - 47
Removing the List Trend Display.....	3 - 47
Graph Trends (Passport 2 Only).....	3 - 48
Modification of Parameters Displayed .....	3 - 49
Modification of Trend Entry Conditions.....	3 - 49
Printing Graph Trend Data.....	3 - 49
Transferring Graph Trend Data Between Different Passport 2 Monitors .....	3 - 49
Clearing Trend Data .....	3 - 49
Removing the Graph Trend Display.....	3 - 50
OXY CRG Display Menu (Passport 2 only) .....	3 - 51
Parameters Displayed .....	3 - 51
Printing OXY CRG Data .....	3 - 51
Transferring OXY CRG Data Between Different Passport 2 Monitors.....	3 - 51
Clearing Trend Data .....	3 - 52
Removing the OXY CRG Display .....	3 - 52
Respiration Monitoring .....	3 - 53
Resp Menu .....	3 - 53
Thoracic Impedance.....	3 - 53
CO <sub>2</sub> Waveform (Passport 2 only) .....	3 - 54

Respiration Monitoring on the Passport 2.....	3 - 54
Thoracic Impedance .....	3 - 54
CO <sub>2</sub> Waveform (requires optional Microstream® CO <sub>2</sub> or Gas Module) (Passport 2 only) .....	3 - 54
Microstream® CO <sub>2</sub> Monitoring (Optional Passport 2).....	3 - 55
Microstream CO <sub>2</sub> .....	3 - 55
Microstream® CO <sub>2</sub> Calibration .....	3 - 56
Gas Module (optional Passport 2).....	3 - 59
Sequence for Monitoring Anesthetic Gases, O <sub>2</sub> , N <sub>2</sub> O and/or CO <sub>2</sub> .....	3 - 59
Gas Module 3 Pre-use Test .....	3 - 61
Gas Monitor Calibration .....	3 - 62
Alarms.....	3 - 65
Setting Parameter Alarm Limits .....	3 - 65
Alarm Limits .....	3 - 66
Auto-Set Alarms.....	3 - 67
Alarm Violations.....	3 - 68
Beep Tones.....	3 - 71
Recorder (Optional) .....	3 - 72
Print Setup Menu .....	3 - 72
Operation of Recorder .....	3 - 72
Printer Formats .....	3 - 73
Laser Printing 12 Lead ECG (optional - Passport 2 only).....	3 - 77
Printing 12 Lead to the Laser printer.....	3 - 77
Laser Printing 12 Lead Format: (Passport 2 only).....	3 - 78
Status Messages .....	3 - 79
NIBP Measurement Messages .....	3 - 79
SpO <sub>2</sub> Messages .....	3 - 80
Recorder Messages (only units equipped with recorder) .....	3 - 81
CO <sub>2</sub> Messages (only units equipped with CO <sub>2</sub> ) .....	3 - 81
Passport 2 / Gas Module Messages (only observed when Gas Module is installed).....	3 - 81
Cooling Fan Message .....	3 - 84
Monitor Problem Solving.....	3 - 85
Connection to Visa or PatientNet Central Stations .....	3 - 88
Connection to Panorama™ Central Station .....	3 - 89
Connection to Panorama™ Gateway.....	3 - 90
<b>User Maintenance .....</b>	<b>4 - 1</b>
Introduction .....	4 - 1
Care and Cleaning of Monitor .....	4 - 1
Decontamination of Monitor .....	4 - 2
Care and Cleaning of SpO <sub>2</sub> Sensors.....	4 - 2
Sterilization and Cleaning of Reusable Bladderless Cuffs .....	4 - 2
Battery Replacement and Maintenance .....	4 - 3
Battery Replacement .....	4 - 3
Battery Maintenance .....	4 - 3
Recorder Paper Replacement.....	4 - 4
Care and Storage of Thermal Chart Paper .....	4 - 4
Care and Cleaning of Gas Module.....	4 - 5
Gas Module II and Gas Module SE .....	4 - 5
Gas Module 3 .....	4 - 6
Care and Cleaning of 3 Lead and 5 Lead ECG Cables and Leadwires.....	4 - 7
Care and Cleaning of View 12™ ECG Cables and Leadwires .....	4 - 7
<b>Accessories .....</b>	<b>5 - 1</b>
Optional Accessories .....	5 - 1

NIBP Accessories.....	5 - 1
Oximetry Sensors and Accessories.....	5 - 2
Pulse Oximetry-Masimo SET® LNOP® SpO <sub>2</sub> .....	5 - 2
Pulse Oximetry-Masimo Set® LNCS® SpO <sub>2</sub> .....	5 - 3
Pulse Oximetry-Nellcor® OxiMax® SpO <sub>2</sub> * .....	5 - 4
Oridion CO <sub>2</sub> Accessories.....	5 - 4
Gas Module Accessories .....	5 - 5
Gas Module II and Gas Module SE .....	5 - 5
Gas Module 3 .....	5 - 5
Reusable Temperature Probes.....	5 - 6
Disposable Temperature Probes.....	5 - 6
ECG Accessories.....	5 - 7
ECG Cables .....	5 - 7
ECG Leadwires .....	5 - 7
12 Lead ECG Accessories .....	5 - 8
Electrodes .....	5 - 8
IBP Accessories .....	5 - 8
Comm-Port Accessories .....	5 - 9
Base Station Accessories .....	5 - 10
Miscellaneous Accessories.....	5 - 10
Mounting Kits and Accessories.....	5 - 10
Upgrade Kits.....	5 - 11
Central Station Accessories.....	5 - 11
<b>Appendix .....</b>	<b>6 - 1</b>
Safety Designations.....	6 - 1
Safety designations per IEC 60601-1 Standard.....	6 - 1
Performance Specifications .....	6 - 3
ECG .....	6 - 3
ECG Performance Requirements .....	6 - 3
Analog Output Specifications.....	6 - 6
3 Lead and 5 Lead ECG .....	6 - 6
Arterial Blood Pressure .....	6 - 7
Sync Pulse for Cardioversion .....	6 - 7
Systole Detector and Heart Rate Meter .....	6 - 7
ECG Derived Heart Rate Meter Performance Requirements .....	6 - 7
IBP Derived Heart Rate Meter Performance .....	6 - 9
SpO <sub>2</sub> Derived Heart Rate Meter Performance .....	6 - 9
NIBP Derived Heart Rate Meter .....	6 - 9
S-T Segment Analysis .....	6 - 9
S-T Segment Analysis Performance Requirements .....	6 - 9
Arrhythmia Analysis.....	6 - 10
12-Lead ECG Interpretation .....	6 - 11
NIBP Sub-System Performance Characteristics .....	6 - 11
Pressure Measurement System .....	6 - 12
Pulse Rate .....	6 - 12
Maximum Cuff Pressure .....	6 - 12
Cuff Inflation .....	6 - 12
Maximum Leakage .....	6 - 13
Vent Rate .....	6 - 13
NIBP Sub-System Functional Requirements .....	6 - 13
Initial Conditions .....	6 - 13
NIBP Starting Pressure Settings and Ranges .....	6 - 13

NIBP Measurement Cycle .....	6 - 13
IBP Parameter Sub-System Performance Characteristics .....	6 - 14
IBP Performance Requirements .....	6 - 14
IBP Connector Type .....	6 - 14
IBP Transducer Performance .....	6 - 14
IBP Heart Rate Meter .....	6 - 14
Temperature Parameter Performance Characteristics .....	6 - 15
Connector Type .....	6 - 15
Temperature Performance Requirements .....	6 - 15
Respiration .....	6 - 16
ECG Respiration Performance Requirements .....	6 - 16
CO <sub>2</sub> Respiration Performance Requirements .....	6 - 17
SpO <sub>2</sub> .....	6 - 17
Masimo® SpO <sub>2</sub> Performance Requirements .....	6 - 17
Masimo® Pulse Rate Performance .....	6 - 19
Nellcor SpO <sub>2</sub> Performance Requirements .....	6 - 20
Nellcor SpO <sub>2</sub> Pulse Rate Performance Requirements .....	6 - 20
CO <sub>2</sub> .....	6 - 21
MediCO <sub>2</sub> Microstream® (Only in monitors with serial numbers below TS10000.) .....	6 - 21
MiniMediCO <sub>2</sub> Microstream® (Only in monitors with serial number TS10000 and higher.) .....	6 - 22
Physical Characteristics .....	6 - 23
Printer .....	6 - 23
Comm-Port .....	6 - 24
Physical Characteristics .....	6 - 24
Communication Characteristics .....	6 - 24
Normal Operating Noise .....	6 - 25
Battery .....	6 - 26
Sealed Lead Acid Battery (P/N 0146-00-0043) .....	6 - 26
Lithium-Ion Battery (P/N 0146-00-0069) .....	6 - 26
AC Power .....	6 - 27
Real Time Clock .....	6 - 27
Power Selection .....	6 - 27
Fan Control .....	6 - 27
Trend Storage .....	6 - 27
Transferring Monitor Default Settings .....	6 - 28
Installation and Use of "Extended Trend" feature .....	6 - 28
Display .....	6 - 28
Environmental Conditions .....	6 - 29
Passport 2/Passport 2 LT .....	6 - 29
Gas Module 3 .....	6 - 30
Agency Compliance .....	6 - 31
Passport 2/Passport 2 LT .....	6 - 31
Gas Module II and Gas Module SE .....	6 - 31
Gas Module 3 .....	6 - 32
Electromagnetic Capability .....	6 - 32
Passport 2/Passport 2 LT .....	6 - 32
Gas Module SE and Gas Module 3 .....	6 - 36
Indirect Blood Pressure Measurements And Associated Errors .....	6 - 39
Precautions While Making Automatically Cycled Blood Pressure Measurements .....	6 - 40
Cuff Size .....	6 - 40
Other Factors .....	6 - 40
User Verification Of Passport 2 Measurements .....	6 - 40



Newborn NIBP Technique.....	6 - 41
How To Get Help.....	6 - 41
Warranty.....	6 - 42
USA, Canada, Mexico, and Puerto Rico.....	6 - 42
Mindray DS's Responsibility .....	6 - 43
Extended Warranty.....	6 - 43

## Foreword

The **Passport 2/Passport 2 LT** Operating Instructions are intended to provide information for proper operation.

General knowledge of monitoring and an understanding of the features and functions of the Mindray DS **Passport 2/Passport 2 LT** Monitor are prerequisites for its proper use.

Do not operate this monitor before reading these instructions.

Information for servicing this instrument is contained in the **Passport 2/Passport 2 LT** Service Manual, Part No. 0070-00-0441. For additional information or assistance, please contact an authorized Mindray DS representative in your area.

**CAUTION: U.S. Federal Law restricts this device to sale by or on the order of a physician or other practitioner licensed by state law to use or order the use of this device.**

**NOTE: Figures in this manual are provided for reference purposes only. Screens may differ based on the monitoring device configuration, licenses available, parameters selected and patient configuration of the Passport 2/ Passport 2 LT Monitor.**

Patents: This device is covered under one or more of the following U.S. Patents 4,621,643, 4,653,498, 4,700,708, 4,770,179, 4,869,254, 4,911,167, 4,928,692, 4,934,372, 5,078,136, 5,351,685, 5,368,026, 5,368,224, 5,482,036, 5,490,505, 5,533,507, 5,632,272, 5,685,299, 5,758,644, 5,769,785, 5,823,950, 6,002,952, 6,036,642, 6,067,462, 6,157,850, 6,206,830, 6,247,674, 6,377,845, 4,802,486, 4,960,126, 5,485,847, 5,743,263, 5,865,736, 6,011,986, 6,035,223, 6,263,222, 6,298,252, 6,463,310, 6,501,975, 6,591,123, 6,675,031, 6,708,049, 6,801,797, 6,589,028, 6,896,713, Re.35,122 and foreign equivalents. Possession or purchase of this device does not convey any express or implied license to use the device with replacement parts which would, alone, or in combination with this device, fall within the scope of one or more of the patents relating to this device.

## Warnings, Precautions And Notes

Please read and adhere to all warnings, precautions and notes listed here and in the appropriate areas throughout this manual.

A **WARNING** is provided to alert the user to potential serious outcomes (death, injury, or serious adverse events) to the patient or the user.

A **CAUTION** is provided to alert the user to use special care necessary for the safe and effective use of the device. They may include actions to be taken to avoid effects on patients or users that may not be potentially life threatening or result in serious injury, but about which the user should be aware. Cautions are also provided to alert the user to adverse effects on this device of use or misuse and the care necessary to avoid such effects.

A **NOTE** is provided when additional general information is applicable.

## Warnings

- WARNING:** Internal Electrical Shock Hazard - This unit does not contain any user-serviceable parts. Do not remove instrument covers. Refer Servicing to qualified personnel.
- WARNING:** Trace Gas Hazard - When using the optional Gas Module, a health hazard exists when trace amounts of vaporized anesthetic agents are chronically inspired by operating room personnel. See Appendix A in NFPA 56A on Inhalation Anesthetics. During any procedure where such agents are employed, the Gas Module exhaust output should be connected to a medical gas-scavenging system.
- WARNING:** Do not use this monitor during MRI (Magnetic Resonance Imaging) scanning. Induced current could potentially cause burns. Accuracy of measurements on this unit and the MRI unit may also be affected.
- WARNING:** For continued protection against a fire hazard, replace all fuses with the specified type and rating. See the Passport 2 Service Manual, P/N 0070-00-0513-01.
- WARNING:** Do not clean the monitor while it is on and/or plugged in.
- WARNING:** This unit uses a common isolation path for the ECG leads and the Invasive Pressure Channels. Ensure that conductive parts of the ECG electrodes do not contact other conductive parts including earth ground. Do not connect any non-isolated accessories to the Passport 2 or to the ECG or invasive pressure channel inputs when connected to a patient. Insure that the total chassis leakage currents of all connected units does not exceed 300 $\mu$ A. Use an IEC 601-1 approved isolation / separation transformer if required. Do not simultaneously touch the patient and any piece of electrical equipment if any cover has been removed from the equipment.
- WARNING:** The AC line cord and interface cables (ie non-patient cables) may utilize the same ground. Therefore, removal of the AC line cord does not necessarily isolate the Passport 2, if non-patient interface cables are attached.
- WARNING:** Observe extreme caution when a defibrillator is used on a patient. Do not touch any part of patient, table, or monitor when a defibrillator is in use.
- WARNING:** Microstream<sup>®</sup> waste material and CO<sub>2</sub> filter should be treated as biohazard material.
- WARNING:** Do not incinerate battery, possible explosion may occur.
- WARNING:** Do not put MPSO (Multiple Portable Socket Outlets ie. Multiple outlet extension cords) used with the Passport 2/ Passport 2 LT or its accessories on the floor. Connect only Passport 2/Passport 2 LT accessories to the same MPSO as the Passport 2/Passport 2 LT. Do not overload the MPSO.

- WARNING:** Compressed gasses are considered Dangerous Goods/ Hazardous Materials per I.A.T.A. And D.O.T. regulations. It is a violation of federal and international law to offer any package or over pack of dangerous goods for transportation without the package being appropriately identified, packed, marked, classified, labeled and documented according to D.O.T. and I.A.T.A. regulations. Please refer to the applicable I.A.T.A. Dangerous Goods Regulations and/or the Code of Federal Regulations 49 (Transportation, Parts 171-180) for further information.
- WARNING:** Pacemaker patients' rate meters may continue to count the pacemaker rate during occurrences of cardiac arrest or some arrhythmias. Do not rely entirely upon rate meter alarms. Keep pacemaker patients under close surveillance. See the Appendix section of this manual for disclosure of the pacemaker pulse rejection capability of this instrument.
- WARNING:** Computerized ECG Analysis should be reviewed by qualified medical personnel. It should not be used exclusively for treatment or non-treatment of patients.
- WARNING:** ST segment measurements may be affected by one or more of the following ECG rhythm morphologies: wide complex QRS such as bundle branch blocks, ventricular pacemaker rhythm, left ventricular hypertrophy or Wolff-Parkinson-White Syndrome. Consult with qualified medical personnel prior to treatment or non-treatment.
- WARNING:** The View 12™ ECG Analysis Module is not intended for use during electrosurgery. If the electrosurgical ground connection is not satisfactory, there exists a possibility of patient burns at the ECG electrode sites.
- WARNING:** Route cables neatly. Ensure cables, hoses and wires are away from a patient's neck to avoid strangulation. Keep floors and walkways free of cables to reduce risk to hospital personnel, patients and visitors.
- WARNING:** The arrhythmia analysis feature is intended to detect ventricular rhythms, however, due to physiologic differences in patient populations, the Passport 2/Passport 2 LT may occasionally sound a false alarm or may not recognize some arrhythmia patterns.
- WARNING:** Operation of the Passport 2/Passport 2 LT below the minimum amplitude or value of patient physiological signal may cause inaccurate results.
- WARNING:** Use of accessories, transducers and cables other than those specified in the manual may result in increased Electromagnetic Emissions or decreased Electromagnetic Immunity of the Passport 2/Passport 2 LT. It can also cause delayed recovery after the discharge of a cardiac defibrillator.
- WARNING:** The use of gas sampling accessories in Gas Module 3 other than specified by Mindray DS may cause significant measurement errors and patient risk.

- 
- WARNING:** Use of accessories, transducers and cables other than those specified in the manual may result in increased Electromagnetic Emissions or decreased Electromagnetic Immunity of the Gas Module 3.
- WARNING:** With the exception of stacking on a Gas Module with the appropriate mounting brackets, the Passport 2/Passport 2 LT should not be used adjacent to or stacked with other equipment. If adjacent or stacked use is necessary, the Passport 2/Passport 2 LT should be observed to verify normal operation in the configuration in which it will be used.
- WARNING:** With the exception of stacking under a Passport 2/Passport 2 LT with the appropriate mounting brackets, the Gas Module 3 should not be used adjacent to or stacked with other equipment. If adjacent or stacked use is necessary, the Gas Module 3 should be observed to verify normal operation in the configuration in which it will be used.
- WARNING:** Ensure that the conductive parts of ECG electrodes do not contact other conductive parts, including earth ground.
- WARNING:** Ensure that the ECG leadwires are neatly secured in a manner that will prevent them from encircling the patient's neck, creating a strangulation hazard.
- WARNING:** Connection of the Gas Module exhaust port to the hospital's waste gas scavenge system is strongly recommended to prevent exposure of hospital personnel to the patient's respiratory sample. Vacuum (negative pressure) should not exceed 1 mmHg at the Gas Module Pump Exhaust fitting. Excessive scavenge vacuum may result in damage to the Gas Module's internal pump.
- WARNING:** When using the Gas Module, the maximum sampling rate at the nasal cannula is 200 ml/min (120 ml/min for Gas Module 3 with a neonatal water trap). This device should not be used on patients whose breathing could be impaired by this vacuum flow rate.
- WARNING:** If the water trap breaks or becomes damaged during operation, there is a risk that bacteria and/or mucus may contaminate the Gas Module.
- WARNING:** Do not use Adult/Pediatric type water traps and/or sampling lines with neonates to avoid high sampling flow.
- WARNING:** When using Microstream® CO<sub>2</sub> Monitoring, the maximum sampling rate at the nasal cannula is 50 ml/min. This device should not be used on patients whose breathing could be impaired by this vacuum flow rate.
- WARNING:** Perform the decontamination process with the unit powered down and power cord removed.
- WARNING:** The Gas Module must not be used with flammable anesthetic agents.
- WARNING:** The Gas Module water trap, sampling line and airway adapter should be disposed of in accordance with local regulations for contaminated and biologically hazardous items.

- WARNING: Do not clean the Gas Module while it is on and/or plugged in.**
- WARNING: Connect only DRYLINE™ gas sampling lines to the water trap. Note that there may be other compatible tubes present that must not be used, e.g. IV lines.**
- WARNING: Do not use DRYLINE™ Neonatal sampling lines (blue Luer lock nuts) with DRYLINE™ Adult/Pediatric water traps as this could result in incorrect measurement data.**
- WARNING: Do not use DRYLINE™ Adult/Pediatric sampling lines (colorless Luer lock nuts) with DRYLINE™ Neonatal water traps as this could result in incorrect measurement data.**
- WARNING: The contents of the water trap should be handled as a potential infection hazard.**
- WARNING: Do not use other cleaning methods for the DRYLINE™ water traps. Do not clean or wash the filter housing of the water trap. Never allow alcohol to enter the filter housing. Never force air through the water trap.**
- WARNING: Do not use a damaged or broken unit or accessory.**
- WARNING: Do not reuse disposable devices.**

---

## Precautions

- CAUTION:** Only use the Abbreviated Operating Check List (0070-00-0493) if you are already familiar with this product. If not, please use the Detailed Operating Instructions.
- CAUTION:** Always place the monitor on a rigid, flat surface or on approved mounts. Do not block the vents.
- CAUTION:** Never place fluids on top of this monitor. In case of accidental wetting, wipe clean immediately and have the monitor serviced to ensure no hazard exists.
- CAUTION:** Do not operate the Passport 2/Passport 2 LT with a frayed or damaged power cord.
- CAUTION:** This unit must only be operated with Mindray DS approved software.
- CAUTION:** NIBP cuffs must be used with the correct Mindray DS hoses. See chapter 5.0 for part numbers.
- CAUTION:** Use only Mindray DS accessories with this product.
- CAUTION:** When cleaning SpO<sub>2</sub> sensors, do not use excessive amounts of liquid. Wipe the sensor surface with a soft cloth, dampened with the cleaning solution.
- CAUTION:** Dispose of single use items in accordance with hospital policy.
- CAUTION:** Do not operate the Passport 2/Passport 2 LT with the ventilation or speaker vents obstructed.
- CAUTION:** To prevent condensation, allow the Passport 2/Passport 2 LT to warm up and dry if it is moved from a cold area to a warm one.
- CAUTION:** Please consult a physician for interpretation of blood pressure measurements.
- CAUTION:** A blood pressure measurement can be affected by the position of the patient, and his / her physiological condition as well as other factors, such as patient movement.
- CAUTION:** Substitution of a component different from that supplied might result in measurement error.
- CAUTION:** The Passport 2/Passport 2 LT may not meet its performance specifications if stored or operated outside of specified temperature and humidity ranges.
- CAUTION:** Prior to use, be sure the rail supporting the bed rail mounting hook can support the weight of the monitor. Consult the bed manufacturer's specifications if necessary. Mindray DS cannot be responsible for injury or damage resulting from improper or inadequate support of the monitor.

- CAUTION:** To assure successful triggering of Intra-Aortic balloon pump from the Passport 2/Passport 2 LT monitor, set the "ECG Filter" to "Extended" and set "Pacer Enhancement" to "On". Both of these settings are located in the ECG setup menu of the Passport 2/Passport 2 LT.
- CAUTION:** The Analog Output on the Passport 2/Passport 2 LT supports triggering the Intra-Aortic Balloon Pump (IABP) for 3 Lead and 5 Lead ECG cable monitoring only. Invasive Blood Pressure triggering is not supported. ECG analog output is disabled when 12 Lead ECG analysis is enabled.
- CAUTION:** Use only Mindray DS supplied power cords, or if a substitute is necessary, use only hospital grade power cords.
- CAUTION:** Removal of the View 12™ ECG Analysis Module without first disabling the 12-Lead ECG card may cause a temporary disruption in patient monitoring.
- CAUTION:** The 2.4 GHz radio optionally used in this device must be at least 20 cm away from the user and/or patient during normal operating conditions.
- CAUTION:** Only connect NIBP Luer fittings to Blood Pressure Cuff or Monitor.
- CAUTION:** To avoid possible damage to the Passport 2/Passport 2 LT, use only ECG cables and accessories available from Mindray DS.
- CAUTION:** Line Isolation Monitor transients may resemble actual cardiac waveforms, thus inhibiting heart rate alarms. Check leadwires for damage and ensure good skin contact prior to and during use. Always use fresh electrodes and follow proper skin preparation techniques.
- CAUTION:** Some pacemakers may contain a respiratory sensor that may produce artifact on an ECG waveform.
- CAUTION:** Thoracic impedance monitoring may affect rate responsive pacemakers.
- CAUTION:** If the dust filter for the fan cannot be cleaned or is damaged, replace it with part number 0378-00-0040. Use of another type of filter may decrease the cooling effectivity and cause damage to the Gas Module.
- CAUTION:** Recharge batteries in the Passport 2/Passport 2 LT.
- CAUTION:** Remove the batteries if the Passport 2/Passport 2 LT is not likely to be used for an extended period of time.
- CAUTION:** Replace sealed lead acid batteries with Mindray DS P/N 0146-00-0043 ONLY. Replace lithium-ion batteries with Mindray DS P/N 0146-00-0069 ONLY.
- CAUTION:** The internal sampling system of the Gas Module does not need to be cleaned or sterilized. There is no reverse flow back to the patient. If the internal sampling system is suspected to be clogged or dirty, the module should be serviced by an authorized service person only.



- CAUTION:** To avoid permanent damage, do not expose metal components (pins, sockets, snaps) to disinfectants, soaps or chemicals.
- CAUTION:** Observe caution on all patients (Neonates, Pediatrics, and Adults) when NIBP is set to the Continuous Mode and the 1 minute interval. When the NIBP "continuous" interval is chosen, the Passport 2/Passport 2 LT will continually take back to back blood pressure readings. As a safety precaution, a limit is placed on continuous and 1 minute interval measurements. In continuous mode, after 5 minutes, the NIBP interval will automatically switch to one measurement taken every 5 minutes. In 1 minute mode, after 10 minutes the NIBP interval automatically switches to measurements taken once every 10 minutes. Reports have been made of nerve injury occurring during use of automatically cycled blood pressure cuffs. See the Appendix, "Cautions when Using Automatically Cycled Blood Pressure Cuffs".
- CAUTION:** When equipped with Masimo<sup>®</sup> SpO<sub>2</sub>, use only Masimo oxygen transducers including Masimo LNOP<sup>®</sup> patient dedicated adhesive sensors and Masimo PC Series Patient Cable. Use of other oxygen transducers may cause improper oximeter performance.
- CAUTION:** When equipped with Nellcor<sup>®</sup> SpO<sub>2</sub>, use only Nellcor oxygen transducers including Nellcor Oxisensor<sup>®</sup> and OxiMax<sup>®</sup> patient dedicated adhesive sensors. Use of other oxygen transducers may cause improper oximeter performance.
- CAUTION:** Tissue damage or inaccurate measurements may be caused by incorrect SpO<sub>2</sub> sensor application or use, such as wrapping it too tightly, applying supplemental tape, failing to inspect the sensor site periodically, or failing to position it appropriately. Carefully read the sensor directions for use, the Passport 2/Passport 2 LT operating instructions, and all precautionary information before use.
- CAUTION:** Excessive ambient light may cause inaccurate measurements. In such cases, cover the SpO<sub>2</sub> sensor site with opaque material.
- CAUTION:** Inaccurate measurements may be caused by incorrect SpO<sub>2</sub> sensor application or use; significant levels of dysfunctional hemoglobins, (e.g., carboxyhemoglobin or methemoglobin); or intra-vascular dyes such as indocyanine green or methylene blue; exposure to excessive illumination, such as surgical lamps (especially ones with a xenon light source), bilirubin lamps, fluorescent lights, infrared heating lamps, or direct sunlight; excessive patient movement; venous pulsations; electro-surgical interference; and placement of a sensor on an extremity that has a blood pressure cuff, arterial catheter, or intra-vascular line.
- CAUTION:** In certain situations in which perfusion and signal strength are low, such as in patients with thick or pigmented skin, inaccurately low SpO<sub>2</sub> readings will result. Verification of oxygenation should be made, especially in preterm infants and patients with chronic lung disease, before instituting any therapy or intervention.

- CAUTION:** Many patients suffer from poor peripheral perfusion due to hypothermia, hypovolemia, severe vasoconstriction, reduced cardiac output, etc. These symptoms may cause an inability to acquire physiological data.
- CAUTION:** The site should be checked at least every eight (8) hours (every four (4) hours with the Adult re-usable SpO<sub>2</sub> finger sensor). Ensure proper adhesion, skin integrity, and proper alignment. Nail polish and fungus may affect readings. Exercise extreme caution with poorly perfused patients. Skin erosion and pressure necrosis can be caused when sensors are not frequently monitored. Assess the site every two (2) hours with poorly perfused patients.
- CAUTION:** If the SpO<sub>2</sub> sensor or patient cable is damaged in any way, discontinue use immediately. To prevent damage do not soak or immerse the sensor in any liquid solution. Do not attempt to sterilize.
- CAUTION:** Vacuum (negative pressure) should not exceed 1 mmHg at the Passport Pump Exhaust fitting. Excessive scavenge vacuum may result in an "OCCLUSION" message or damage to the Passport 2's internal pump. The scavenge system must be on during calibration.
- CAUTION:** During the decontamination process, do not get the LpH SE Germicidal detergent into any vent openings.
- CAUTION:** Gas Module 3 must be moisture protected whenever transported. This can be done with a protective plastic bag in which water-absorbing materials (e.g. silica gel) have been included.
- CAUTION:** Contamination with CO<sub>2</sub>, N<sub>2</sub>O or Anesthetic Agent in the air surrounding the Gas Module 3 may cause significant measurement errors.

## Notes

- NOTE:** This unit is not designed to be used with a peripheral pulse sensor. SpO<sub>2</sub> is a standard function in this monitor, and may be used to obtain a plethysmograph waveform and heart rate.
- NOTE:** The comparison testing conducted via the auscultatory method used both Phase 4 and Phase 5 Korotkoff sounds. Reports of study findings for both the auscultatory method as well as the intra-arterial methods are available by contacting Mindray DS Technical Support (800) 288-2121, ext. 8116.
- NOTE:** Potential hazards due to errors in software or hardware have been minimized by actions taken in accordance with IEC 60601-1-4.

---

## Intended Use

The intended use for the Passport 2<sup>®</sup> includes the monitoring of the following human physiological parameters:

- ECG waveform derived from 3, 5 or 12 lead measurements
- Heart Rate derived from selected sources (SpO<sub>2</sub>, ECG, IBP, NIBP)
- Blood Oxygenation (SpO<sub>2</sub>) measurement/waveform
- ST Segment Analysis derived from 5 to 12 lead measurements
- Lethal Arrhythmia Detection derived from 5 to 12 lead measurements
- Non Invasive Blood Pressure (NIBP) measurement
- Invasive Blood Pressure (IBP) measurement/waveform measurable at two sites
- Respiration Rate/ waveform derived from ECG or CO<sub>2</sub>
- CO<sub>2</sub>, Inspired and end tidal microstream/waveform
- Temperature measurement via YSI 400/700 series probes
- Interpretation of Resting 12 lead ECG

The target populations are adult, pediatric and neonate with the exception of the:

- Lethal Arrhythmia Detection and ST Segment Analysis for which the target populations are adult and pediatric only, and
- Interpretation of Resting 12 Lead ECG, for which the target population is adult only.













The monitor is intended for use in the health care facility setting.

The device has the capacity of interfacing with Mindray DS's Gas Modules, displaying the measurements of Anesthetic Gases, O<sub>2</sub>, N<sub>2</sub>O, and CO<sub>2</sub>.

## Unpacking

Remove the instrument from the shipping carton and examine it for signs of shipping damage. Save all packing materials, invoice, and bill of lading. These may be required to process a claim with the carrier. Check all materials against the packing list. Contact the Mindray DS Service Department (800) 288-2121, ext. 8116 for prompt assistance in resolving shipping problems.

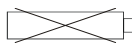
## Symbols and Descriptions

<b>SYMBOL</b>	<b>DESCRIPTION</b>	<b>SYMBOL</b>	<b>DESCRIPTION</b>
	Attention, Consult Accompanying Documents / Refer to Manual		Type B Equipment
	Dangerous Voltage		Type BF Equipment
	Equipotentiality		Defibrillator Proof Type BF Equipment
	Alternating Current (AC)		Defibrillator Proof Type CF Equipment
	Direct Current (DC)		Alarm Off Icon
	On (only for a part of the equipment)		Alarm Mute Icon
	OFF (only for a part of the equipment)		Earth (Ground)
	Data Input		Protective Earth (Ground)
	Data Output		Battery Charging
	Data Input / Output		Full Battery
	Gas Port Input		Low Battery
	Gas Port Output		No Battery Present
	NIBP Connection		Latex-free product
IABP	Analog ECG and IBP output for communication to an Intra- Aortic Balloon Pump	DEFIB	Analog ECG out and Sync Pulse for connection to a defibrillator
	Crossed out wheelex bin indicates separate treatment from general waste at end of life		Interference may occur in the vicinity of equipment marked with this symbol
	For single-patient use only, do not reuse.		Manufacturer's reference/catalogue number



For Neonatal use



Manufacturer's batch number



Not for Neonatal use



Serial number



Conformité Européenne (CE)  
Marking of Conformity to  
European Medical Device  
Directive. CE<sub>XXXX</sub> represents the  
Notified Body number



Software Version

# General Description

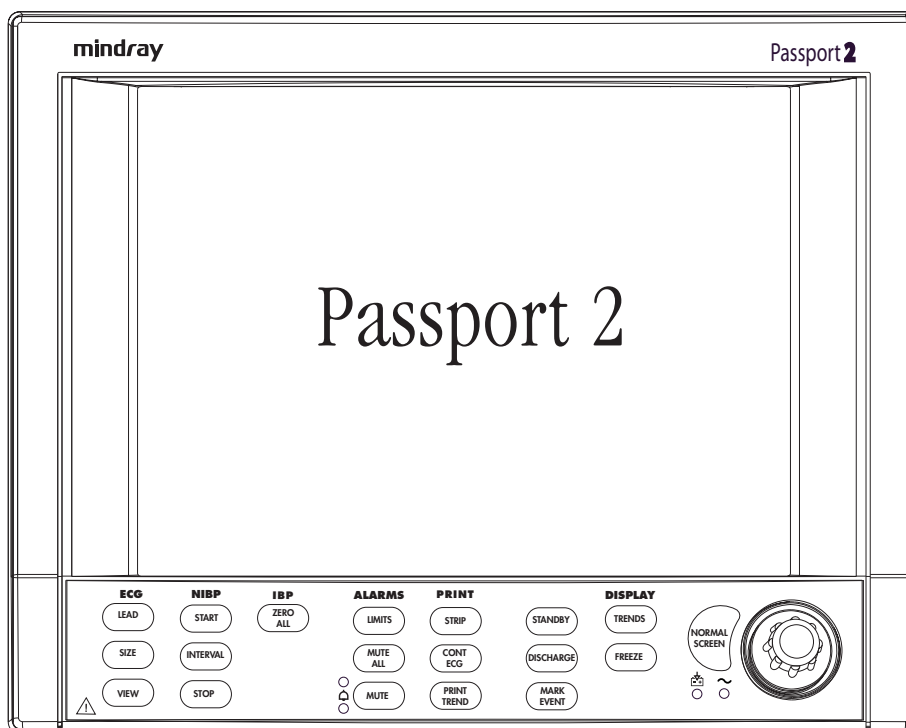

The Mindray DS **Passport 2/Passport 2 LT** is a vital signs monitor intended for intrahospital use on human patients. The **Passport 2** is a six (6) trace monitor, the **Passport 2 LT** is a three (3) trace monitor. The unit has many features and functions, yet is very easy to use through an integrated keypad, Navigator™ Control Knob and intuitive menu system. The patient parameters that can be monitored with the **Passport 2/Passport 2 LT** are: ECG, Masimo SET® SpO<sub>2</sub>, Nellcor® Oxismart® or OxiMax® SpO<sub>2</sub>, Non-invasive Blood Pressure, Respiration Rate and Temperature. Parameters optional for the **Passport 2** are: 3 lead or 12 lead ST analysis with adjustable ISO and J points, Arrhythmia analysis, Invasive Blood Pressure, Gases, Microstream® CO<sub>2</sub> and 12 Lead ECG Interpretation.

The **Passport 2/Passport 2 LT** Monitor can be mounted on a rolling stand, a wall mount bracket, gas machine arm, Bedrail or operated as a tabletop instrument. The **Passport 2** monitor can be mounted to a Gas Module. The keypad contains dedicated primary functions. The menu buttons provide access to setting up patient information, waveforms, and parameters.

The **Passport 2** comes with a color TFT LCD or a monochrome display. The **Passport 2 LT** comes with a passive color or monochrome display. Digital displays are provided for Heart Rate, Non-invasive Blood Pressure (NIBP), Pulse Oximetry (SpO<sub>2</sub>), Respiration Rate and Temperature (T1). Additional digital areas present for the **Passport 2** are Invasive Blood Pressure (IBP1 and IBP2) (optional), Anesthetic Agents (optional), O<sub>2</sub> and NO<sub>2</sub> (optional), ST (optional), and CO<sub>2</sub> (optional). The optional built-in recorder provides hard copies of all digital data and waveforms as well as Tabular Trend information.

The View 12™ ECG Analysis Module for the **Passport 2** enables 12-Lead Acquisition, Continuous 12-Lead ST Analysis and Arrhythmia Analysis with print capability. The View 12™ ECG Analysis Module consists of a PCMCIA card for insertion into the **Passport 2** with 12 Lead software, an M-12 cable and a detachable leadwire set.

The **Passport 2** has the capability of interfacing with IABP Systems and Mindray DS's Central Stations, Gas Module, Remote Displays and Nurse Call Systems.

The **Passport 2 LT** has the capability of interfacing with IABP Systems and Mindray DS's Remote Displays, and Nurse Call Systems.

The optional Gas Module can be used on an anesthesia cart or mounted on a rolling stand or wall mounted.

The **Passport 2/Passport 2 LT** monitor is powered from an AC connection or internal batteries. Batteries can be purchased separately as optional equipment. See Chapter 5.0.

The **Passport 2/Passport 2 LT** monitor can operate with either battery removed so that fresh batteries can be installed during monitor operation.

Key features of the **Passport 2/Passport 2 LT** are:

- 3 or 5 Lead (I, II, III, aVR, aVL, aVF, V) ECG
- 12 Lead (I, II, III, aVR, aVL, aVF, V1, V2, V3, V4, V5, V6) ECG (optional **Passport 2**)
- ECG Cascade
- ESIS Capability (3 or 5 Lead ECG only)
- 2 invasive blood pressure channels (optional **Passport 2**)
- 3 or 12 Lead ST Analysis with adjustable ISO and ST points (optional **Passport 2**)
- Arrhythmia Analysis (optional **Passport 2**)
- 12 Lead ECG Interpretation (optional **Passport 2**)
- Non-invasive Blood Pressure (NIBP)
- Lead Selectable Impedance Respiration
- Masimo SET<sup>®</sup> SpO<sub>2</sub>
- Nellcor<sup>®</sup> Oxismart<sup>®</sup> and OxiMax<sup>®</sup> SpO<sub>2</sub> (optional)
- Microstream<sup>®</sup> CO<sub>2</sub> (optional **Passport 2**)
- Gas Module Connectivity (optional **Passport 2**)
- 1 YSI 400/700 temperature channel
- Automatic sensor detection and waveform display
- Automatic Heart Rate source selection
- Auto-Set<sup>™</sup> Alarms
- Dual channel thermal array recorder (optional)
- Color TFT LCD display or Monochrome display (**Passport 2**)
- Monochrome display (**Passport 2 LT**)
- Battery operation (optional)
- Tabular 120 entries (500 entries optional)
- Graphic Trend display (**Passport 2**)
- Extended Trend Display, 500 entries (optional)
- OXY CRG display, 6 minutes (12 hours optional) (**Passport 2**)
- 6 trace erase bar refresh (**Passport 2**)
- 3 trace erase bar refresh (**Passport 2 LT**)
- Navigator<sup>™</sup> Control Knob
- Internal isolated power module
- External Remote Color Display Available with Color TFT LCD Equipped Monitor (optional **Passport 2**)
- External Interfaces with IABP Systems and Mindray DS's Central Stations, Gas Module, Remote Displays, Nurse Call Systems and Serial Communications (**Passport 2**)
- External Interfaces with IABP Systems (**Passport 2 LT**)



- Communication with hospital CIS (Clinical Information Systems) through DIAP (Mindray DS Improved ASCII Protocol, manual P/N 0070-00-0307) (**Passport 2**)
- Inter-Monitor Patient Data Transfer (with optional accessories)
- Inter-Monitor System Set-up Transfer (with optional accessories)
- Mounting Kits (optional accessory)
- Soft-Grip Handle
- Comm-Port (optional **Passport 2**)
- Dual PCMCIA Interface

---

## 2.0 *Controls, Indicators and Connectors*

---

This section of the Operating Instructions identifies and describes each control and display of the Mindray DS **Passport 2/Passport 2 LT** Monitor.

Step-by-step instructions for operation of the monitor are provided in Section 3.0 "Operation".

## 2.1 Front Panel

The front panel keys are used to access many main functions quickly and easily. Figure 2-1 below shows the keys and a brief explanation of each key.

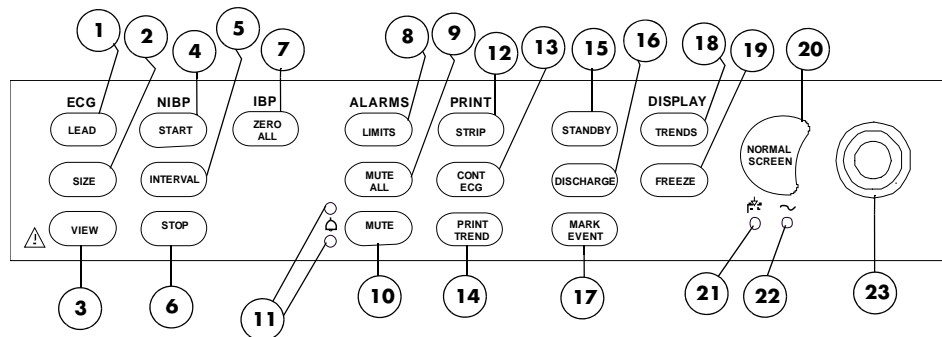

**FIGURE 2-1** Front Panel Controls

### 1. (ECG) LEAD

Press this key to select the next ECG lead to display in waveform 1. Each time you press this key, the next available ECG lead displays.

### 2. (ECG) SIZE

Press this key to select the next available Size of ECG for Waveform 1. Each time you press this key, the next available ECG Size displays. When the largest ECG size is displayed, the next key press displays the smallest size.

### 3. (ECG) VIEW

Press the **VIEW** key to see 6 leads of ECG at once when using the View 12™ ECG Analysis Module or the 5 Lead ECG cable. With a View 12™ ECG Analysis Module installed, press the **VIEW** key once to see the first 6 leads of ECG, press again to view another 6 ECG leads. Pressing a third time will return to normal display view. With a 5 lead ECG cable, press the **VIEW** key once to see 6 leads of ECG, press again to return to normal display view.

**NOTE:** Pressing the **VIEW** key does not affect the waveforms being transmitted to the Central Station.

### 4. (NIBP) START

Press this key to begin an NIBP measurement or to begin or re-start automatic interval measurements.

## 5. (NIBP) INTERVAL

Press this key to modify the NIBP interval measurement time. The choices are: Off, Cont, 1 min, 2 min, 2.5 min, 3 min, 5 min, 10 min, 15 min, 20 min, 30 min, 1 hr, 2 hrs or 4 hrs. The "Off" selection means that NIBP measurements can only be initiated manually. The "Cont" selection means that measurements will be continuous (one right after the other). The continuous measurement interval will only last for 5 minutes and then automatically change to a 5 minute interval. The 1 minute interval will last for 10 minutes and then automatically change to a 5 minute

## 6. (NIBP) STOP

Press this key to stop any NIBP measurement. If the interval mode is activated, pressing this key disables the interval mode measurements. An **NIBP Idle** message displays until the interval mode is restarted. If a **Press STOP to clear.** message is displayed, pressing this key will clear a Cuff Overpressure condition.

## 7. (IBP) ZERO ALL

Press this key to set the current pressure of all the invasive pressure channels to zero provided the channel(s) do not have an existing pressure being monitored. During the zeroing process, the message **Zeroing** is displayed. The message **Zero Complete** displays when the zeroing process is successful. If the zero process is not successful, the message **Unable to Zero** is displayed. Available with **Passport 2** monitor only.

## 8. (ALARMS) LIMITS

Press this key to display the Alarm menu. The Alarm menu provides you access to view or change alarm values.

## 9. (ALARMS) MUTE ALL

Press this key to suspend audio alarms on all parameters. The alarms remain suspended for a user selected amount of time. This amount of time is set in the Alarms Setup menu. While the alarms are suspended, an Alarm Mute icon is displayed next to each silenced parameter. Also, the message **All Alarms Muted for XX:XX mins** displays. XX:XX is the time remaining in minutes and seconds. Press this key again during the suspended alarm time to re-enable the audio alarm. If the suspend time was set to Permanent, the message **All Alarms Permanently Muted** displays.

## 10. (ALARMS) MUTE

Press this key to suspend audio alarms on all currently alarming parameters. The alarms remain suspended for a user selected amount of time as set in the Alarms Setup Menu or when the alarm condition is no longer present. Any new alarms that occur while the alarm tone is silenced will disable the silence and sound the alarm tone. While the alarms are suspended, an Alarm Mute icon is displayed next to each silenced parameter.

## 11. (Alarms) LED Indicators

A set of 2 LED's used to indicate that an alarm has been tripped. The WARNING (or Priority 1) LED is red and the CAUTION (or Priority 2) LED is yellow.

## 12. (PRINT) STRIP

Press this key to initiate a 16 second print out of selected waveforms on the internal printer. Press this key during the printing to stop the printer. With a View 12™ ECG Analysis Module installed, press the **VIEW** key, then press the **STRIP** key to initiate a 12-lead Interpretative report that will be printed at either the internal recorder or a laser printer. If the print destination is a remote Central Station, then pressing this key will initiate a printout at the Central Station.

## 13. (PRINT) CONT ECG

Press this key to initiate a continuous ECG 1 and 2 waveform printout on the internal printer. Press this key during the printing to stop the printer.

## 14. (PRINT) PRINT TREND

Press this key to initiate the printing of the desired trend. By default, the monitor's stored trend information will be printed by the internal printer. Press this key during the printing to stop the printer. If the print destination is a remote Central Station, then pressing this key will initiate a trend report at the Central Station.

## 15. STANDBY

Press this key to place the **Passport 2/Passport 2 LT** into a STANDBY mode. While in STANDBY mode, monitoring is discontinued and the alarms are in permanent suspension, interval NIBP measurements are placed in idle mode, CO<sub>2</sub> pump is shut off, and the display shuts down. When in the STANDBY mode, the message **STANDBY. TO BEGIN MONITORING, PRESS STANDBY** is displayed. Press the **STANDBY** key again to exit the STANDBY mode and return to the normal screen.

**NOTE:** Trend data is not cleared in the STANDBY mode. When the STANDBY mode is released, NIBP INTERVAL is in IDLE MODE and requires re-activation via the START key. The CO<sub>2</sub> pump automatically reactivates if the Microstream® sensor is in place.

## 16. DISCHARGE

Press this key to initiate the process of discharging the patient from the monitor. A menu titled **Patient Discharge** will be displayed. Depending on the monitor's configuration, the **Normal Screen** menu choice will be provided along with one or more of the following selections: **Discharge From Monitor**, **Discharge From Central** and **Discharge From Both**. If any discharge option is selected, a confirmation box will be displayed. (Discharging a patient from the monitor deletes all patient trend and demographic data and places the monitor in STANDBY mode.) An onscreen message will display as follows:

- For Main Module Software Versions Y.xx and earlier, the message **STANDBY. TO BEGIN MONITORING, PRESS STANDBY** is displayed.
- For Main Module Software Versions AA.xx and later, the message **PATIENT DISCHARGED. MONITOR IN STANDBY MODE - TO BEGIN MONITORING, PRESS STANDBY** is displayed.

Upon exiting STANDBY mode, the monitor configuration reverts to currently saved settings. Selecting **Normal Screen** from the menu aborts the discharge.

**17. MARK EVENT**

Press this key to cause a time stamp event marker to be noted in the trend memory. If connected to a Panorama Central Station, a time stamp event marker will also be noted in the Central Station's trend memory.

**18. (DISPLAY) TRENDS**

Press this key to display the List Trend screen. Press this key a second time to display the Graph Trend screen. Press this key a third time to return to the Normal Display. If Neonate or Pediatric is selected as the patient size, a third press will display the OXY CRG display. A fourth press will then return the monitor to normal display.

**19. (DISPLAY) FREEZE**

Press this key to freeze the waveform display. When waves are frozen, the message **WAVES FROZEN** is displayed. Digital data will continue to be updated.

**20. NORMAL SCREEN**

Press this key at any time to return the screen to the normal monitoring mode. All menus are closed.

**21. Battery Charging LED**

A green LED located below the battery icon indicates that the battery charger is active. The charger will not always be active when AC power is present. It is dependent on the battery type (sealed lead acid vs. lithium-ion) and battery charge condition. The LED is not an indication of the condition of the batteries or their charge level. Charged batteries must be installed in the monitor to ensure uninterrupted operation while switching from AC to battery power.

**22. AC Power LED**

A green LED beside the Battery Charging LED that is used to indicate that the unit is connected to the AC Power within the facility.

**23. Navigator™ Control Knob**

Rotate this knob to highlight the various menus on the display. Press the center of the knob to display the highlighted menu. Once a menu is displayed, rotate the knob to highlight the items within the menu. Press the center of the knob to select a highlighted item.

## 2.2 Display

The display of the **Passport 2/Passport 2 LT** provides menus, waveforms, parameter information, and messages. Figure 2-2 below shows the layout of the screen. The display can be a color LCD or monochrome flat panel for the **Passport 2** monitor. The display for the **Passport 2 LT** is a monochrome panel. The number of waves displayed can vary from 3 to 6 (**Passport 2 LT** is limited to 3). The default operation follows these basic rules:

- a. If a wave and related parameter tile are displayed, they are horizontally linked and have the same color for easy and clear reading. The ECG parameter may violate this rule since multiple vectors can be viewed at one time.
- b. NIBP and Temperature data is displayed only in the lower row of boxes. With the **Passport 2** monitor, as the fourth, fifth and sixth waves are sensed they will automatically insert and fill the bottom waveform areas.
- c. Font size for parameter data vary with the amount of data on the screen to maximize the size of the numbers.

The monitor also includes a display set-up function that allows the user to customize the display. User preferred set-ups can be programmed and saved.

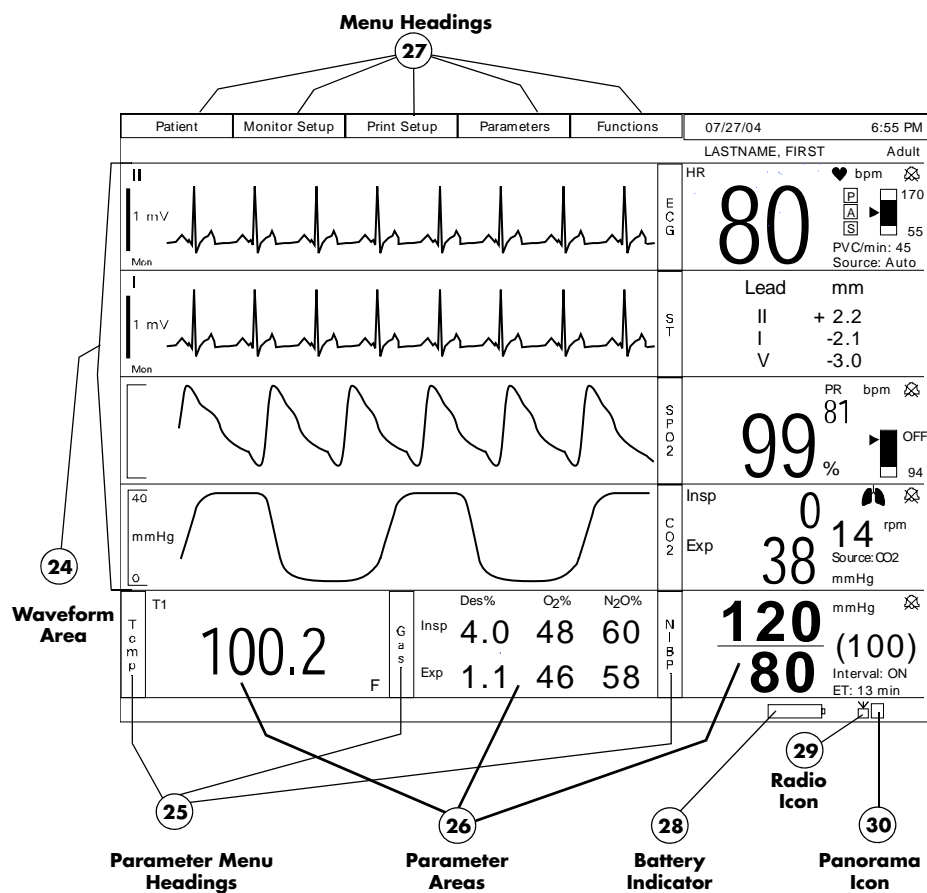

**FIGURE 2-2** Display

## 24. Waveform Area

The waveform area is used to display the windows that contain parameter waveforms. Up to 6 waveforms can be displayed. The top window is always set to display the ECG waveform and cannot be changed. By default, SpO<sub>2</sub> (Pleth) will appear as the second waveform, if connected. Respiration or CO<sub>2</sub> will appear as the third waveform. If pressure transducers are plugged into IBP connectors, the screen will reformat to display additional waveforms, and IBP will appear as the fourth and fifth waveforms. Except for the top window that is reserved for ECG, the windows can be changed to display any of the available parameters and waveforms. Each window contains a menu heading, which can be selected with the Navigator™ Control Knob.

## 25. Parameter Menu Heading

Using the Navigator™ Control Knob, select a parameter menu heading, change the waveform and / or set specific information for the parameter. See the next section for a description of each menu.

## 26. Parameter Area

The parameter areas contain the digital data for each available parameter.

## 27. Menu Headings

Using the Navigator™ Control Knob, select a menu to set or review specific information. See the next section for a description of each menu.

## 28. Battery Indicator

When batteries are installed and the monitor is functioning on battery power, the battery indicator provides a visual reference for the approximate charge level of the batteries. See the following examples.



**Full Battery**

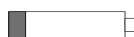

**Low Battery**

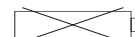

**No Battery Present  
(Lithium-ion batteries only)**

If the monitor is configured for lithium-ion batteries, when there are no batteries installed, the battery indicator will be displayed with an "X" through it as shown in the example.

When the battery charge is low, but not below the cutoff voltage, the battery indicator will begin to flash and a low pitched double beep will be generated every minute.

**NOTE:** When the battery indicator begins to flash, less than 15 minutes of operating time remains, depending upon the number of functions that are operational.

**NOTE:** The internal recorder may not be operational when the battery charge is low.



**29. Radio Icon** 

If a Panorama Instrument Radio - 608 is installed and "WMTS Enabled" is set to "Yes" (in the Installation Menu), this icon will be displayed.

**30. Panorama Icon**  or 

This icon will display in one of two possible formats as follows:

- If the **Passport 2** 608 radio is sending data but it is not being displayed at a Panorama Central Station, then this icon will display the number "1".
- If the **Passport 2** data is being displayed at a Panorama Central Station, then this icon will display the capital letter "V".

## 2.3 Menus

The Main Menu system of the **Passport 2/Passport 2 LT** is available through the Menu headings, which are always displayed on the screen. The headings are accessed using the Navigator™ Control Knob. Turning the Control Knob highlights the Menu headings one at a time. When the Menu heading that you would like to access is highlighted, press the center of the Control Knob to display the menu. Turn the Control knob again to highlight items within the Menus headings and press the Control Knob to select the highlighted item. If selecting the highlighted item displays more selections, continue using the Control Knob in the same manner (turn to highlight, press to select) to set the options as desired. The Menu headings are:

### 2.3.1 Patient

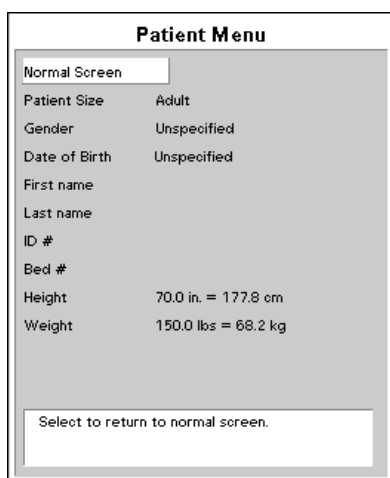

The screenshot shows a screen titled "Patient Menu". At the top left, there is a button labeled "Normal Screen". Below this, the following fields are displayed:

Patient Size	Adult
Gender	Unspecified
Date of Birth	Unspecified
First name	
Last name	
ID #	
Bed #	
Height	70.0 in. = 177.8 cm
Weight	150.0 lbs = 68.2 kg

At the bottom of the screen, there is a button labeled "Select to return to normal screen."

**FIGURE 2-3** Patient Menu

**NOTE:** Changes that are made in the Patient Menu do not become effective until the menu is closed.

## Patient

MENU ITEM	SELECTIONS	DEFAULT/COMMENTS
Patient Size	Adult, Pediatric, Neonate	Adult
Gender	Unspecified, Male, Female	Default is Unspecified. Use Navigator Control Knob to select patient's gender.
Date of Birth		Default is Unspecified. Use Navigator Control Knob to select patient's date of birth.
Last Name		A keyboard displays. Use the Navigator™ Control Knob to enter the patient's LAST name.
First Name		A keyboard displays. Use the Navigator™ Control Knob to enter the patient's FIRST name.
ID # <sup>1</sup>		A keyboard displays. Use the Navigator™ Control Knob to enter the patient's ID #.
Bed # <sup>2</sup>		A keyboard displays. Use the Navigator™ Control Knob to enter the patient's Bed #.
Height	8" to 120" (20 cm to 305 cm)	Adult - 70" Pediatric - 30" Neonate - 20"
Weight	0.1 lbs to 1100 lbs (0.1 kg to 500 kg)	Adult - 150 lbs Pediatric - 15 lbs Neonate - 6 lbs
Admit Patient <sup>3</sup>	Yes, No	Default is No. Select Yes to admit patient to the central station. (This selection appears only when connected to a VISA or PatientNet® Central Station.)

- 1 The "ID #" field can accept a maximum of 15 characters. If a Passport 2 608 radio is communicating with a Panorama Central Station, only the first 10 characters will be displayed in the "ID" field at the Central Station.
- 2 The "Bed #" field can accept a maximum of 15 characters. However, since only the first 5 characters will be displayed in the "Bed" field at a Panorama Central Station if a Passport 2 608 radio is communicating with the Central Station, the following standard format for this demographic is recommended:
  - Start the string with a room # that has a fixed number of digits. For example, if the maximum number of digits that is used in numbering the rooms is 4, then for room 102, a leading zero would be added to get the 4th digit - 0102.
  - Follow the room # with a letter to identify the particular bed within the room. For example, a room with 2 beds would have bed A and bed B.
  - An example of a complete "Bed #": Bed B in room 513 (in a facility where the maximum number of digits that is used in numbering the rooms is 4) would be identified as 0513B.

**NOTE:** If the monitor is communicating with the EMR (Electronic Medical Records) system through a Panorama Gateway, any changes to patient demographics made at the monitor will not be sent to the EMR system. For further explanation, refer to section 3.26, "Connection to Panorama • Gateway".

- 3 Passport 2 only.

## 2.3.2 Monitor Setup

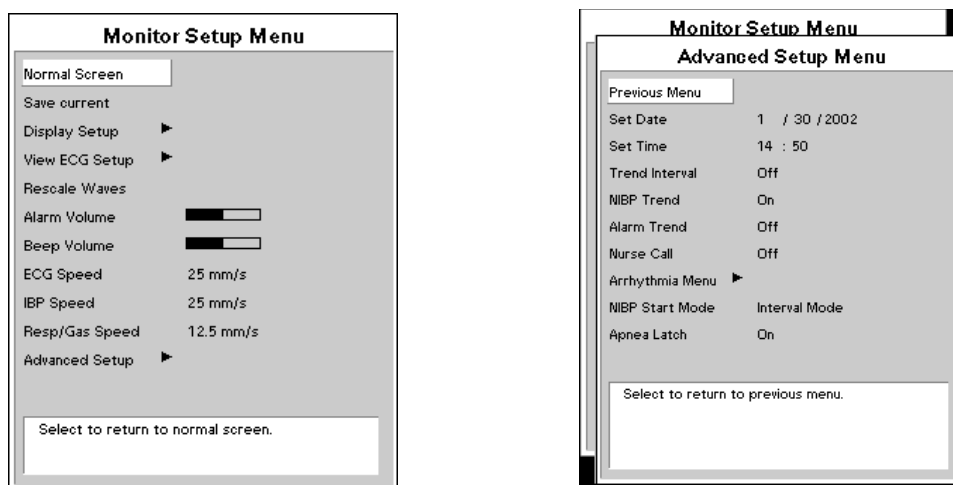

**FIGURE 2-4** Monitor Setup

### Monitor Setup Menu

MENU ITEM	SELECTIONS	FACTORY DEFAULT/COMMENTS
Normal Screen		Select to return to normal screen.
Save Current		A confirmation prompt appears. Select Yes to save the current settings as the "monitor" defaults.
Display Setup		Open an additional menu which allows you to change the positions of the parameters and waveforms.
View ECG Setup		Open an additional menu which allows you to change the ECG leads viewed when you press the <b>VIEW</b> key.
Rescale Waves		Select to auto-scale all waveforms.
Alarm Volume	Variable from Minimum to Maximum	Mid-Scale / Displays a slide bar to adjust the setting of the alarm volume. Use the Navigator™ Control Knob to adjust the volume.
Beep Volume	Variable from Off to Maximum	Mid-Scale / Displays a slide bar to adjust the setting of the systole beep volume. Use the Navigator™ Control Knob to adjust the volume.
ECG Speed	6.25, 12.5, 25, 50 mm/sec	25 mm/sec / Select to change trace speed of ECG & Pleth waveforms.
IBP Speed	6.25, 12.5, 25, 50 mm/sec	25 mm/sec / Select to change trace speed of pressure waveforms.

\* *Passport 2 only.*

## Monitor Setup Menu (Continued)

MENU ITEM	SELECTIONS	FACTORY DEFAULT/COMMENTS
Resp/Gas Speed	3, 125, 6.25, 12.5, 25 mm/sec	12.5 mm/sec / Select to change trace speed.
Advanced Setup		Select to set these menu items: <ul style="list-style-type: none"> <li>• Set Date</li> <li>• Set Time</li> <li>• Trend Interval</li> <li>• NIBP Trend</li> <li>• Alarm Trend</li> <li>• Nurse Call*</li> <li>• Arrhythmia Menu*</li> <li>• NIBP Start Mode</li> <li>• Apnea Latch</li> </ul>

\* *Passport 2 only.*

## Advanced Setup Menu

MENU ITEM	SELECTIONS	FACTORY DEFAULT/COMMENTS
Previous Menu		Select to return to previous menu.
Set Date		Select to change date. Changing the date will clear the trend information. A confirmation message will display.
Set Time		Select to change time. Changing the time will clear the trend information. A confirmation message will display.
Trend Interval	Off, 1, 2.5, 5, 10, 15, 20, 30 min, 1 hr, 2 hrs	Off / Select to change time of trend data collection.
NIBP Trend	On, Off	On / Select to save numeric data to trend on NIBP measurements.
Alarm Trend	On, Off	Off / Select to save numeric data to trend on Alarms.
Nurse Call	Off, 1 second, Continuous	Off / Select to choose the Nurse Call activation time.
Arrhythmia Menu*		This selection will open the Arrhythmia Menu.
NIBP Start Mode	Interval Mode, Timer Mode	Interval Mode / Select the Interval mode to synchronize NIBP start with the integral clock. Select Timer Mode to synchronize NIBP start with the interval selected in relation to the real time clock.
Apnea Latch	On, Off	On / Select to turn apnea alarm latching on or off.

\* *Passport 2 only.*

## Arrhythmia Menu (Optional)

<b>MENU ITEM</b>	<b>SELECTIONS</b>	<b>FACTORY DEFAULT/ COMMENTS</b>
Previous Menu		Use Navigator™ Control knob to return to the previous menu.
Arrhythmia	All On, All Off, Non-lethals Off	Factory default is All On. Use Navigator Control knob to turn arrhythmia analysis on or off.
Irregular HR**	On, Off	Factory default is On. Use Navigator Control knob to turn Irregular HR on or off.
V-Tach Threshold	3 to 15 beats	Factory default is 3 beats. Use Navigator Control knob to select how many ventricular beats in a row will constitute V-Tach.
V-Tach Rate	100 to 180 bpm	Factory default is 120 bpm. Use Navigator Control knob to select the heart rate threshold which must be reached to constitute V-Tach.
Asystole Delay	3 to 10 seconds (3/5 lead) 3 to 8 seconds (12 lead)	Factory default is 4 seconds. Use Navigator Control knob to select the number of seconds with an absence of an R wave that will constitute asystole.
Relearn		Use Navigator Control knob to select to relearn Arrhythmia and ST.
ECG Noise Delay**	3 to 30 seconds	Factory default is 5 seconds. Use Navigator Control knob to select the number of seconds to delay the ECG Noise Alarm.

\*\* Only available with 3-lead or 5-lead.

### 2.3.3 Print Setup

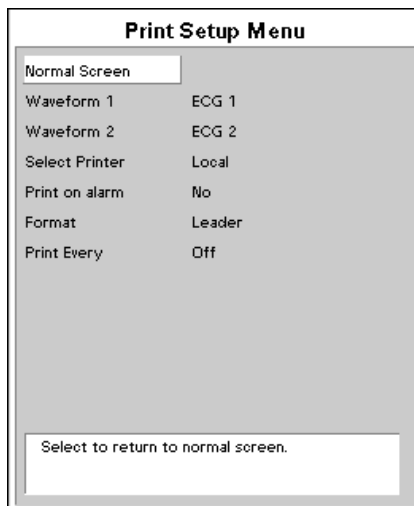

**FIGURE 2-5** Print Setup

#### Print Setup Menu

MENU ITEM	SELECTIONS	DEFAULT/COMMENTS
Waveform 1	ECG 1-6, IBP1,* IBP2,* Pleth, Resp, CO <sub>2</sub> ,* O <sub>2</sub> ,* Agent,* N <sub>2</sub> O*	ECG 1 / Select to choose Waveform 1 on the printer.
Waveform 2	Off, ECG 1-6, IBP1,* IBP2,* Pleth, Resp, CO <sub>2</sub> ,* O <sub>2</sub> ,* Agent,* N <sub>2</sub> O*	ECG 2 / Select to choose Waveform 2 on the printer.
Select Printer	Local, Remote, Local & Remote, Local & Laser**, Laser & Remote**, Laser**	Select printer source for printing waveforms / trends. A default printer or combination of printers can be set.
Print on alarm	Yes, No	No / Select to print data on an alarm occurrence.
Format	Leader, Wave	Leader / Select to format strip with all digital data in the leader or top / bottom of wave.
Print Every	Off, 1, 5, 10, 15, 20, 30, minutes, 1 hr, 2 hrs	Off / Select to set a time interval for automatic printing.
Average ST Complex**		This selection will print the Average ST Complex for this patient to the Local Printer.

\* *Passport 2 only.*

\*\* *Passport 2 only with View 12™ ECG Analysis Module.*

## 2.3.4 Parameters

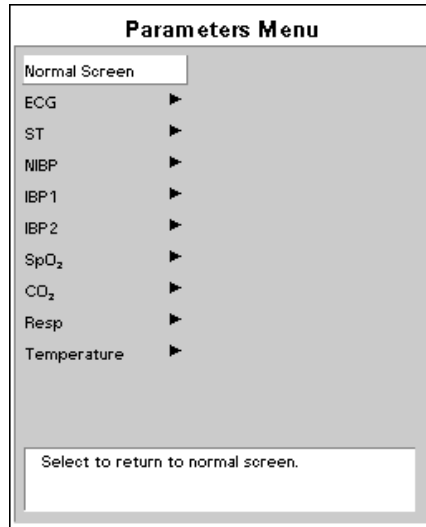

**FIGURE 2-6** Parameters

### Parameters Menu

MENU ITEM	DEFAULT/COMMENTS
ECG	Select to open the respective menu. These can also be selected through the individual parameter menus.
ST*	
NIBP	
IBP1 *	
IBP2 *	
SpO <sub>2</sub>	
CO <sub>2</sub> *	
Resp	
Gases*	
Temperature	

\* *Passport 2 only.*



## 2.3.5 Functions Menu

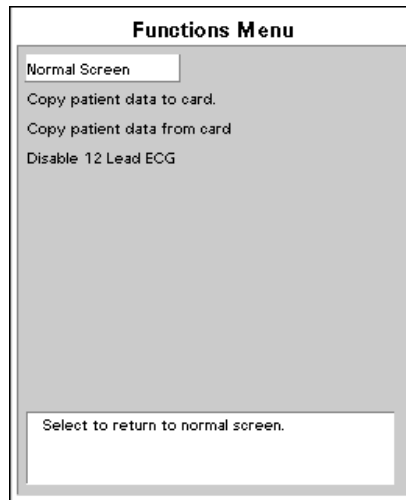

**FIGURE 2-7** Functions Menu

## Functions Menu

<b>MENU ITEM</b>	<b>SELECTIONS</b>	<b>DEFAULT/COMMENTS</b>
Normal Screen		Select to return to normal screen
Copy patient data to card		Select to copy the patient data to a data transfer card.
Copy patient data from card		Select to copy the patient data from a data transfer card.
12-Lead ECG*	Disable / Enable	Use Navigator Control knob to disable or enable 12-Lead ECG.

\* *Passport 2 only with View 12™ ECG Analysis Module. NOTE: If "Enable Network" is set to "Wireless" in the "System Information" menu, 12-Lead ECG will not be listed as a choice in the Functions Menu.*

## 2.4 Left Side Panel

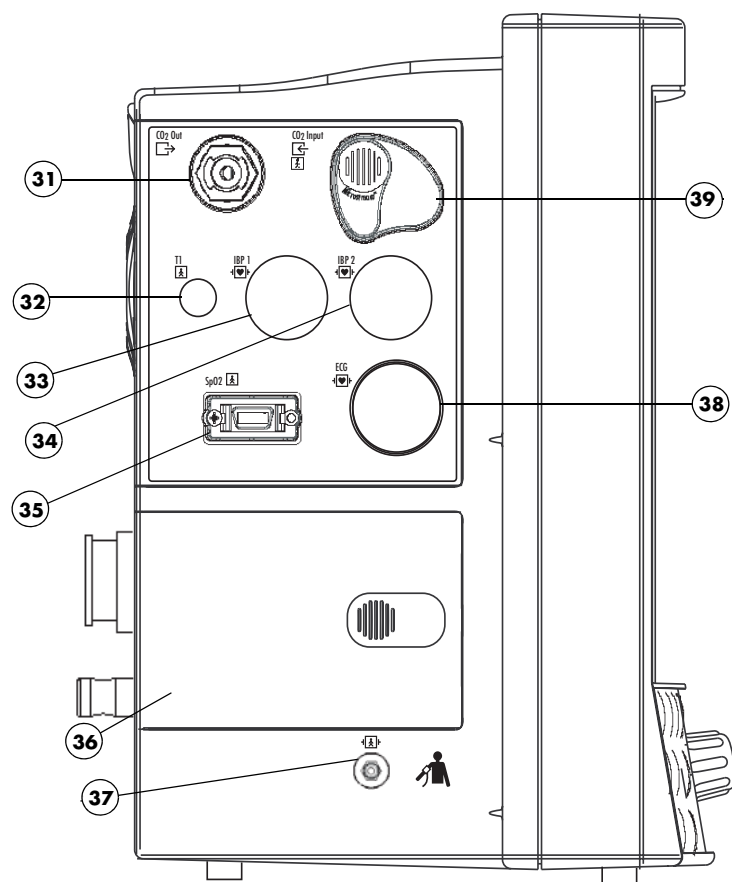

**FIGURE 2-8** Left Side Panel

### **31. CO<sub>2</sub> Exhaust Connector (Optional Passport 2)**

This connector is used to attach an exhaust line which can be used to connect to a gas scavenger system.

### **32. T1 Connector**

A standard three wire phone jack used to mate with either the YSI series 400 or 700 temperature probes. The monitor automatically detects which probe is connected.

### **33. IBP 1 Connector (Optional Passport 2)**

A six-pin male connector used for Channel 1 Pressure Transducer connection. Mindray DS specified pressure transducers are listed in Chapter 5, Accessories.

### **34. IBP 2 Connector (Optional Passport 2)**

A six-pin male connector used for Channel 2 Pressure Transducer connection. Mindray DS specified pressure transducers are listed in Chapter 5, Accessories.

**35. SpO<sub>2</sub> Connector**

A 14-lead Mini-D ribbon type female connector used to attach the SpO<sub>2</sub> sensor to the monitor. See Chapter 5 for the complete listing of approved SpO<sub>2</sub> accessories.

**36. Battery Compartment**

This compartment houses the two optional, user replaceable, rechargeable batteries (sealed lead acid or lithium-ion). These batteries provide power to the unit when it is not connected to an AC receptacle. The batteries can be independently removed and replaced while the unit is operating.

**37. NIBP Rectus Connector**

This connector is used to attach the NIBP hose to the unit.

**38. ECG Connector**

This connector is used to attach ECG cables. Use Mindray DS cables listed in Chapter 5.0, Accessories.

**39. CO<sub>2</sub> Input Connector (optional Passport 2)**

This connector is used to attach the Microstream<sup>®</sup> CO<sub>2</sub> FilterLine<sup>®</sup>, listed in Chapter 5.0, Accessories, to the unit.

## 2.5 Right Side Panel

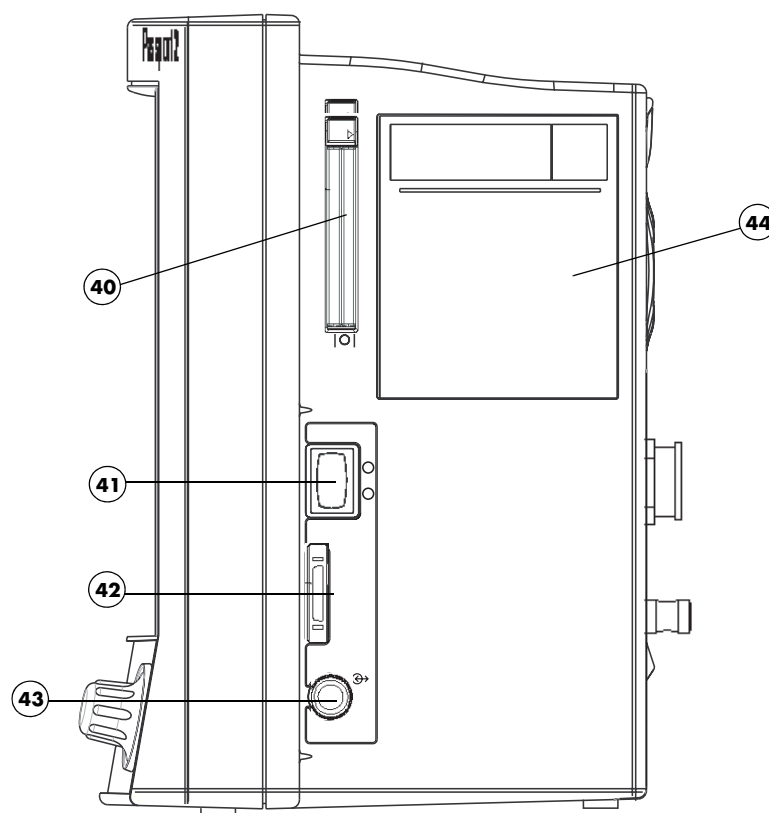

**FIGURE 2-9** Right Side Panel

### **40. PCM1 and PCM2 Card Slots**

These sockets are used for extended trend memory, software download to the CPU, patient data transfer, monitor set-up transfers, View 12™ ECG Analysis Module and Panorama Instrument Radio - 2.4.

### **41. Power Switch**

A momentary switch that turns power ON or puts the unit in STANDBY but does not prevent charging of the batteries. Press the top of the switch once to turn the unit ON. Press the top of the switch again to turn the unit OFF.

### **42. DEFIB Connector**

Used to connect a defibrillator sync cable.

### **43. IABP Connector**

Used for triggering an Intra-Aortic Balloon Pump from the **Passport 2/Passport 2 LT** ECG signal only when using a 3-lead or 5-lead ECG cable.

### **44. Recorder (Optional)**

A two trace thermal strip chart recorder with integral paper spool.

## 2.6 Rear Panel

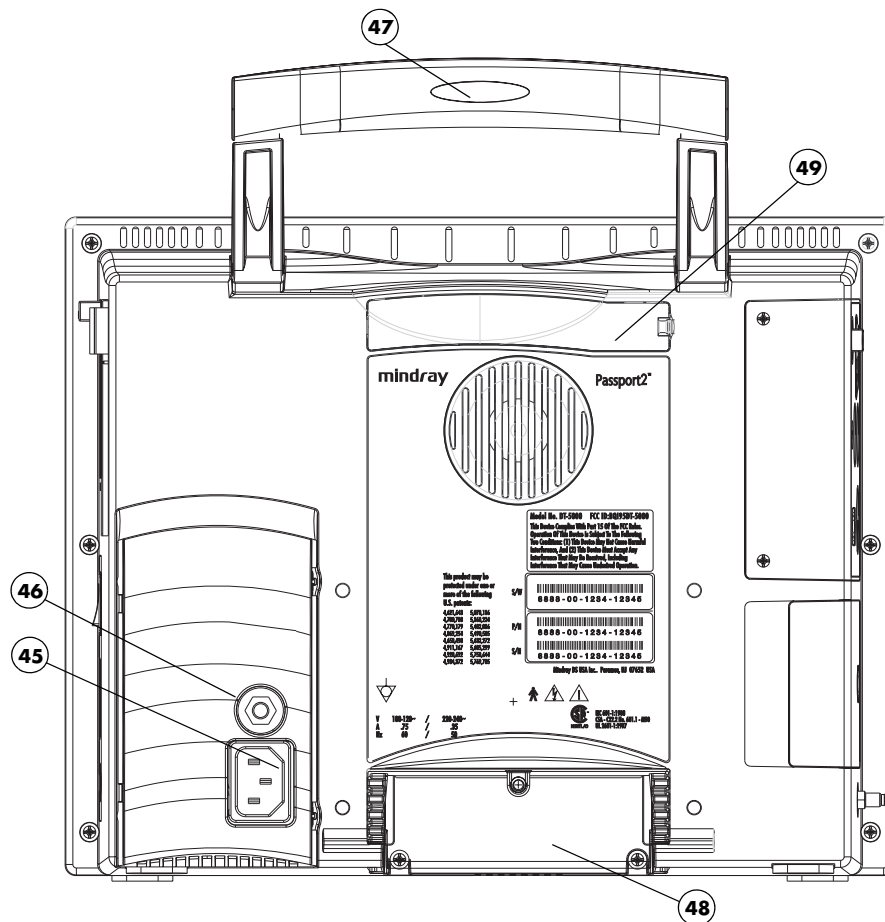

**FIGURE 2-10** Rear Panel

### 45. AC Receptacle

Insert an AC power cord into this connector.

**CAUTION:** Use only Mindray DS supplied power cords, or if a substitute is necessary, use only hospital grade power cords.

### 46. Equipotential lug

Provides Equipotential grounding of hospital equipment

### 47. Soft Grip Handle

Use for carrying the monitor.

### 48. Main I/O Connector Port (DM1)

Area dedicated for the use of an optional communication port.

### 49. Expansion Slot

Used for connecting an optional Panorama Instrument Radio - 608.

## 2.7 Remote Color Display (Passport 2 Only)

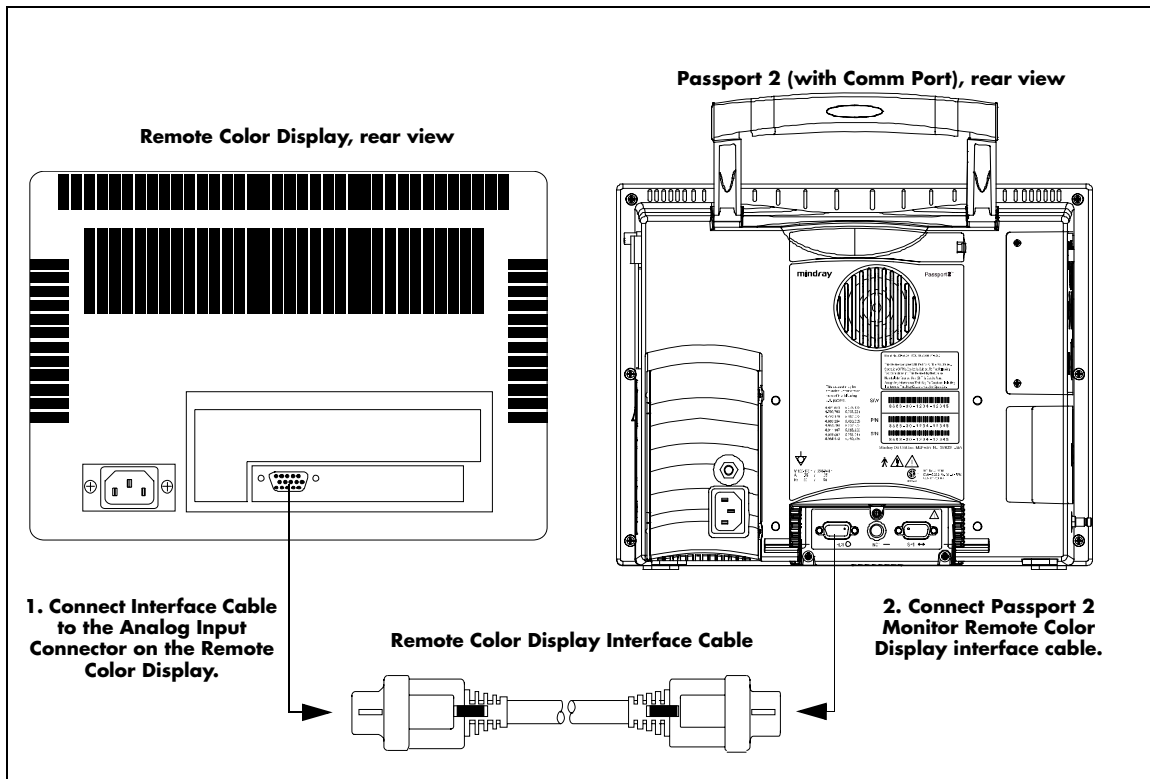

**FIGURE 2-11** Remote Color Display

**NOTE:** Passport 2 monitors equipped with EL (electro-luminescent) displays do not support remote display capabilities.

For instructions on mounting the remote display to a wall, see the **Passport 2** Service Manual, Installation Guide.

## 2.8 Gas Module (Optional Passport 2)

**NOTE:** The following models are referenced in this manual: **Gas Module II, Gas Module SE, and Gas Module 3.** When information is common to all models, the generic name “Gas Module” is used. Information that is unique to a specific model is identified accordingly.

### 2.8.1 Gas Module II and SE

#### 2.8.1.1 Front Panel

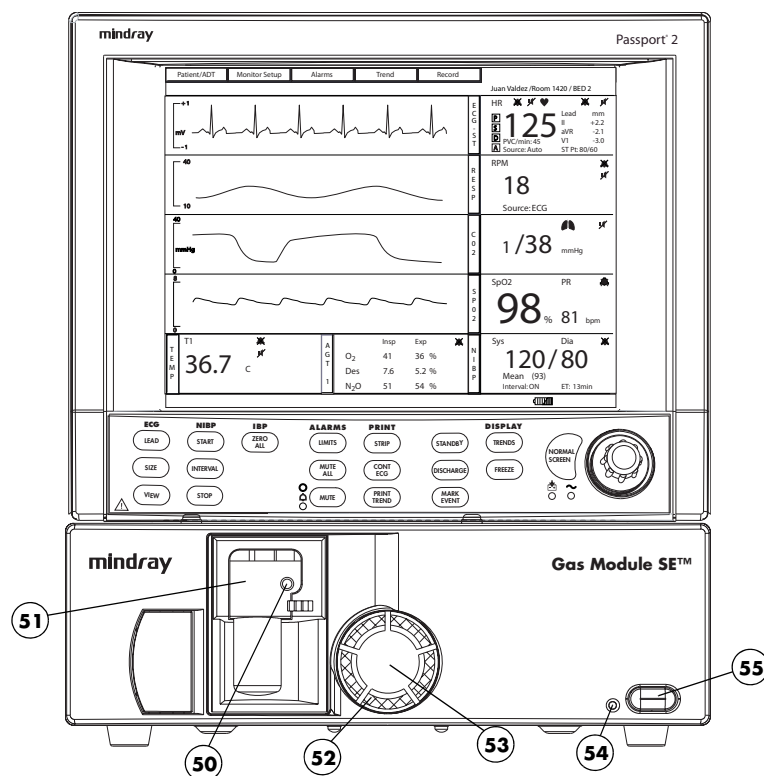

**FIGURE 2-12** Gas Module II and SE - Front Panel

#### 50. Input Port

This port is used to connect the sampling tubing to the Gas Module.

#### 51. Water Trap Assembly (includes Water Trap Reservoir)

The Water Trap Assembly (P/N 0202-00-0129) is used to capture moisture drawn in with the patient sample. The Water Trap Reservoir must be emptied and rinsed (with water only) whenever more than half full or whenever changing patients. Refer to Section 4.9 for more details.

#### 52. Dust Filter

The Dust Filter (P/N 0378-00-0040) protects the Gas Module from airborne dust. It should be removed and cleaned on a regular basis. Refer to Section 4.9 for more details.

**53. Dust Filter Cover**

The Dust Filter Cover is removed to access the filter.

**54. Power Indicator Lamp**

This lamp illuminates when the Power Switch is in the ON position.

**55. Power Switch**

A switch used to power the unit ON and OFF. It is located on the front of the Gas Module SE and on the back of the Gas Module II.

## 2.8.1.2 Rear Panel

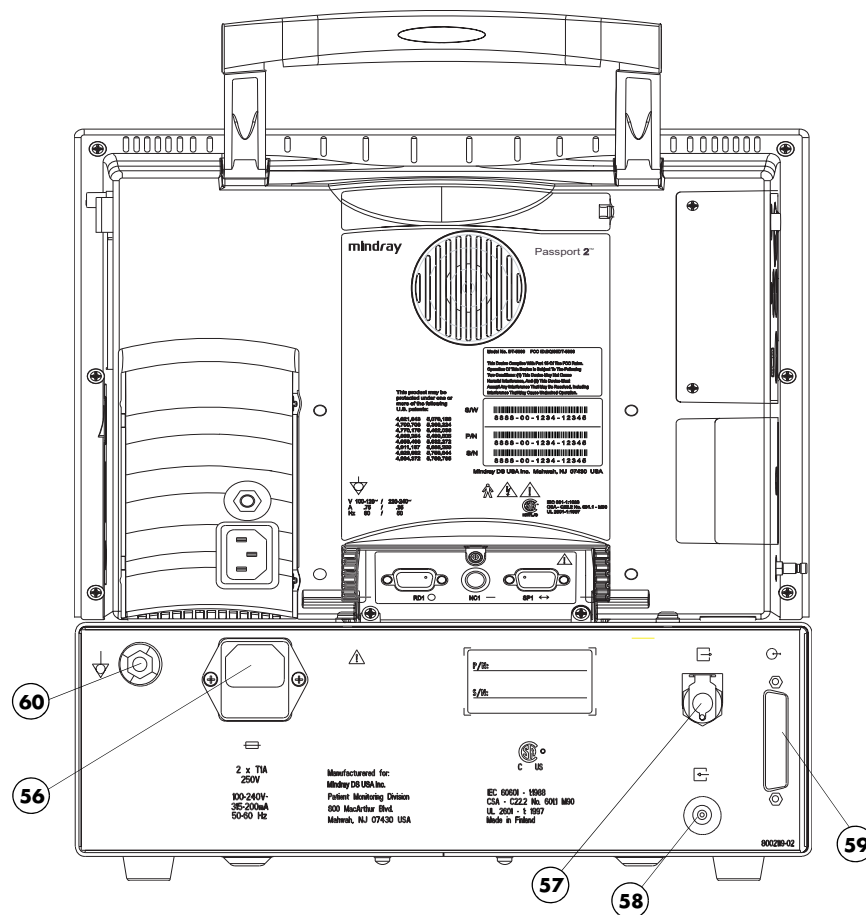

**FIGURE 2-13** Gas Module II and SE - Rear Panel

**56. AC Power Input**

This input is used to attach the special “Y” Shaped Power Cord.

**57. Exhaust Port**

This panel mount coupling is used for attaching a gas scavenging system (P/N 0997-00-0923 or P/N 0997-00-0984) to the Gas Module.



**58. Reference Port**

This port is used only to measure room air. This port is not to be connected to anything. Do not block this port.

**59. External Interface Port**

A communication interface port used to connect the Gas Module to the **Passport 2**.

**60. Equipotential lug**

Provides Equipotential grounding of hospital equipment

## 2.8.2 Gas Module 3

## 2.8.2.1 Front Panel

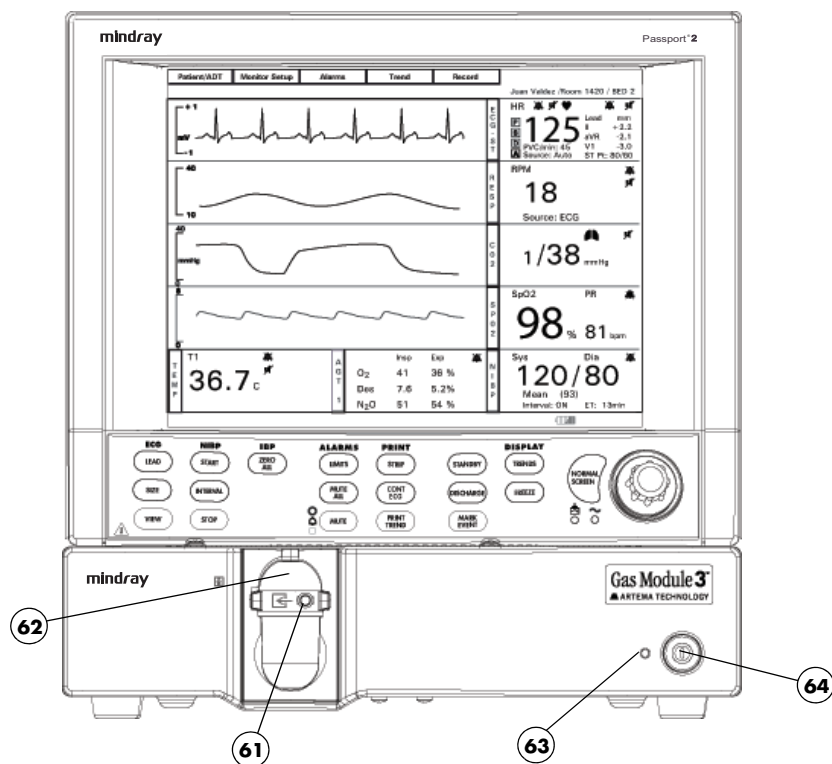

**FIGURE 2-14** Gas Module 3 - Front Panel

**61. Input Port**

This port is used to connect the sampling tubing to the Gas Module.

**62. Water Trap Assembly (includes Water Trap Reservoir)**

The Water Trap Assembly (Adult/Pediatric P/N 0202-00-0182-10, Neonate P/N 0202-00-0181-10) is used to capture moisture drawn in with the patient sample. The Water Trap Reservoir must be emptied and rinsed (with water only) whenever more than half full or whenever changing patients. Refer to section 4.9 for more details.

**63. Power Indicator Lamp**

This lamp illuminates when the Power Switch is in the ON position.

**64. Power Switch**

A switch used to power the unit ON and OFF.

### 2.8.2.2 Rear Panel

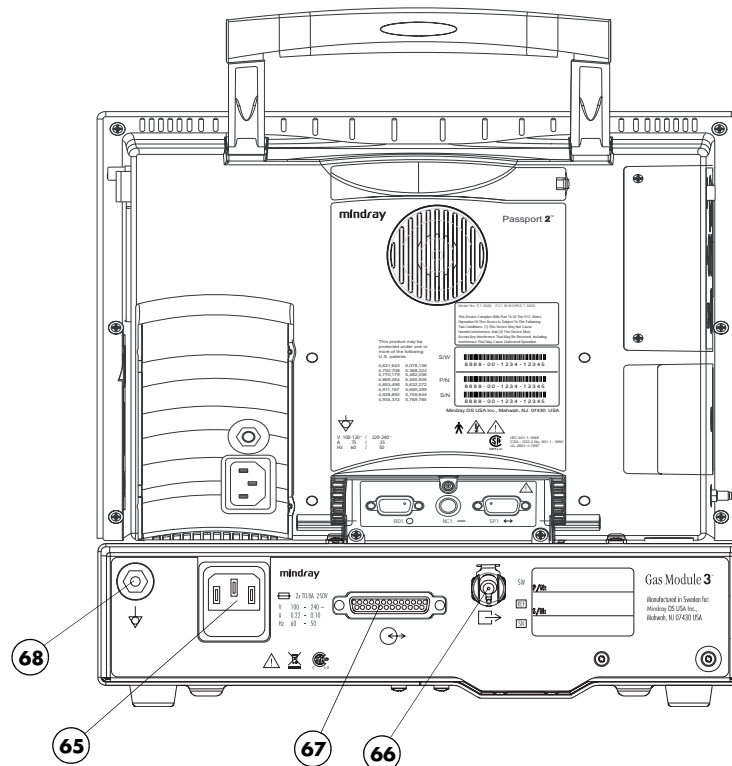

**FIGURE 2-15** Gas Module 3 - Rear Panel

**65. AC Power Input**

This input is used to attach the special “Y” Shaped Power Cord.

**66. Exhaust Port**

This panel mount coupling is used for attaching a gas scavenging system (P/N 0997-00-0923 or P/N 0997-00-0984) to the Gas Module.

**67. External Interface Port**

A communication interface port used to connect the Gas Module to the **Passport 2**.

**68. Equipotential lug**

Provides Equipotential grounding of hospital equipment.

## 2.9 Comm-Port (Optional Passport 2)

**NOTE:** Figures 2-17 to 2-20 depict four distinct sub-models of the Comm-Port that have different interface capabilities. Only one sub-model at a time can be connected to the Passport 2.

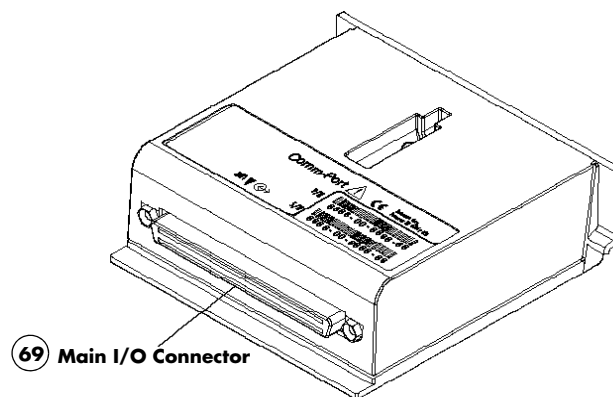

**FIGURE 2-16** Comm-Port Main Connector

### 69. Comm-Port to Main I/O Connector (DB1)

This is the female connector that will engage the equivalent male connector when connected to the **Passport 2**.

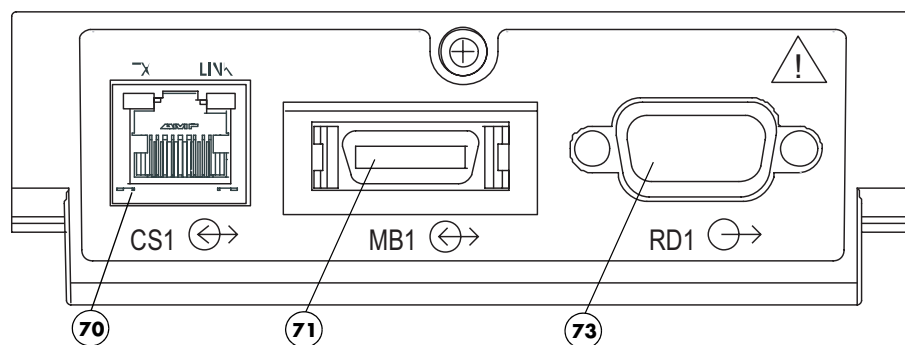

**FIGURE 2-17** Comm-Port 2

### 70. Ethernet Connector (CS1)

Ethernet connection port used for networking connections or devices requiring ethernet communication such as the Panorama™ Central Station or a Laser Printer.

### 71. Module Bus Connector (MB1)

Port used to connect to future enhancements.

### 72. Serial Port Connector (SP1 or SP2)

Proprietary serial port used to connect to the Visa or Patient Net Central Station, Gas Module, or other devices.

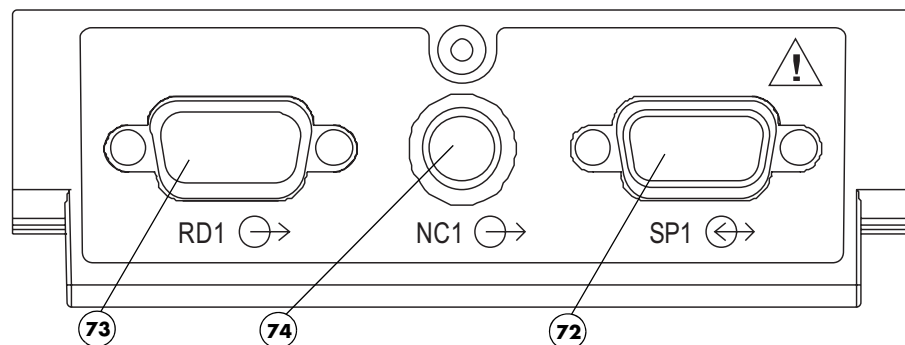

**FIGURE 2-18** Comm-Port 3

**73. Remote Display Connector (RD1)**

Port used to connect a color remote display to the **Passport 2** monitor

**74. Nurse Call Connector (NC1)**

Port used to connect a Nurse Call Cable to the **Passport 2** monitor

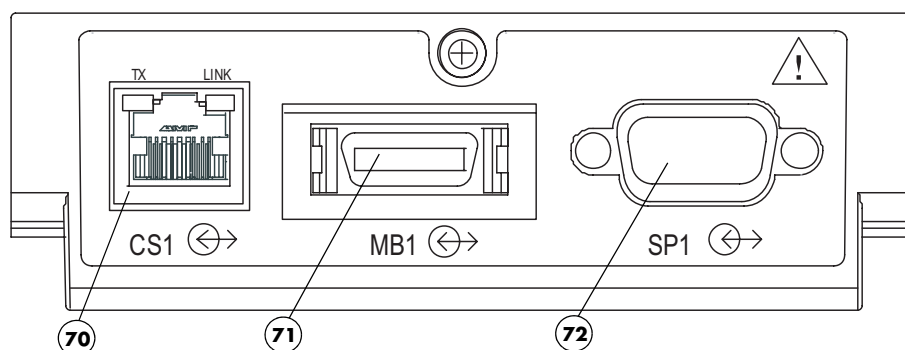

**FIGURE 2-19** Comm-Port 4

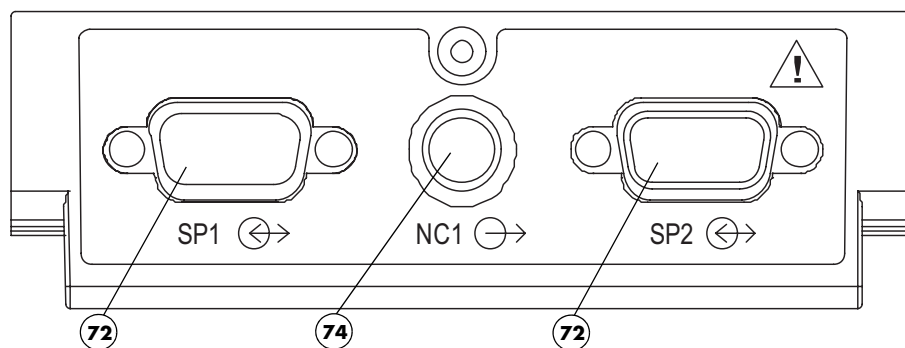

**FIGURE 2-20** Comm-Port 5

**This page intentionally left blank.**

---

## 3.1 Getting Started

The **Passport 2/Passport 2 LT** comes with default factory settings which enable you to begin monitoring without setting any of the waveforms, parameters, alarms, or functions. However, all of these settings can be changed for specific patient or departmental needs.

Certain operating characteristics are based on the selected patient size (e.g., NIBP start pressure). The patient size selection should be matched to the actual patient before monitoring begins.

### 1. Initial Monitor Set-Up

- a. Attach the Line cord to the **Passport 2/Passport 2 LT** and to the AC outlet, respectively.
- b. Attach any peripheral equipment, e.g., Central Station, Remote Color Display, before turning the unit ON.
- c. Plug the unit into a hospital grade AC receptacle. If battery operation is required, ensure that two fully charged batteries are installed.
- d. Press the power switch to turn the unit ON. Internal self-tests will run and the display will come on.

### 2. Setting the Date and Time

The date and time are set in the **Monitor Setup Menu**.

- a. Using the Navigator™ Knob, highlight **Monitor Setup**. Press the Navigator Knob to open the menu.
- b. Use the Navigator Knob to select **Advanced Setup**, then select either **Date** or **Time**.
- c. Turn the Navigator Knob to select a new setting. Once the desired choice is highlighted, press the Navigator Knob.
- d. This setting is saved when **Yes** is selected via the confirmation prompt.

**NOTE: Patient trend data is cleared if the Time and/or Date are changed on the monitor.**

If the Passport 2 is connected to a Panorama Central Station, the Time and Date settings of the Central Station will be acquired by the Passport 2 in one of three ways as follows:

- the Time and/or Date are changed on the Passport 2
- "Clear Trends" is chosen from the List Trend or Graph Trend menus
- the patient is discharged

### 3. Transferring Monitor Default Settings (Optional)

When installing several **Passport 2/Passport 2 LT** monitors with identical display and alarm settings, it is not necessary to set each unit separately. A "Transfer Card" (P/N 0996-00-0051-01) may be used to copy the settings from monitor to monitor.

- a. Ensure that the source monitor is powered OFF.
- b. Insert the Transfer Card into the PCM2 slot on the right side of the source monitor.
- c. Power ON the source monitor while holding down the **DISCHARGE** key to enter into its Installation Mode.
- d. From the Installation Menu, select "**Copy monitor defaults to card.**" A status message will indicate when the process is complete. Remove the Transfer Card.
- e. Ensure that the receiving monitor is powered OFF.
- f. Insert the Transfer Card into the PCM2 slot on the right side of the receiving monitor.
- g. Power ON the receiving monitor while holding down the **DISCHARGE** key to enter into its Installation Mode.
- h. From the Installation Menu, select "**Copy monitor defaults from card.**" A status message will indicate when the process is complete.
- i. Select "**Save Current**" and then restart the receiving monitor to enter normal monitoring mode.

### 4. Installation and Use of "Extended Trend" Feature (Optional)

This feature is added to the **Passport 2/Passport 2 LT** by inserting the "Extended Trend" card (P/N 0996-00-0052-01) into the PCM1 slot on the right side of the monitor. The card is to be inserted before monitor power-up, and never removed during monitor operation. In order to guard against accidental removal, the card slot is designed so that a tool is required to eject the card after insertion.

The "Extended Trend" feature is automatically enabled when the unit is powered-up following card insertion.

### 5. Patient Set-Up

- a. Power ON the monitor. Clear the previous patient's data by pressing the "**DISCHARGE**" key and then selecting "**Discharge From Monitor**" or "**Discharge From Both**" from the Patient Discharge menu.
- b. Connect the patient to the monitor, apply appropriate accessories such as ECG electrodes, NIBP cuff, SpO<sub>2</sub> probe, CO<sub>2</sub> Filterline<sup>®</sup>, etc.
- c. Open the **Patient Menu** and enter the patient demographic data. Ensure that the correct patient size is chosen.
- d. If an NIBP cuff has been applied, press the **START** key to initiate a non-invasive blood pressure measurement.

## 3.2 Installation Mode

### 3.2.1 Installation Menu



**FIGURE 3-1** Installation Menu

The Installation Mode is accessed by pressing and holding the **DISCHARGE** key during power on. See the table that follows for descriptions of the Installation Menu choices.

To enter Installation Mode proceed as follows:

1. Power up the **Passport 2/Passport 2 LT** while holding down the **DISCHARGE** key.
2. Set each item as necessary. To save all of the chosen settings, choose "Save current" before leaving this menu. To return to normal operating mode, power the unit Off and On again.



The following table describes the Installation Mode menu structure:

<b>MENU TITLE ON SCREEN</b>	<b>MENU CHOICES</b>	<b>DEFAULT</b>	<b>ACTIONS/ COMMENTS</b>
Save Current			Select to save current settings as defaults.
Select Language		Set up at factory	Select to change language.
Select Country		Set up at factory	Select to change country.
Date Format	M/D/Y, D/M/Y, Y/M/D	Per country	Select to change date format.
Time Format	12, 24 hour	Per country	Select to change time format.
NIBP Timeout	15, 30, 45, 60 mins	15 min.	Select to change NIBP display time out.
Temperature units	°F, °C	°F - USA °C - All others	Select to change temperature units.
Weight Units	lbs, kg	lbs - USA kg - All others	Select to change weight units.
Height Units	ft/ inches, cm	ft/ inches - USA cm - All others	Select to change height units.
CO <sub>2</sub> Units	mmHg, %, kPa	mmHg	Select to change CO <sub>2</sub> units.
Copy monitor defaults from card.			Select to copy the monitor defaults and settings from a data transfer card inserted into PCM2.
Copy monitor defaults to card.			Select to copy the monitor defaults and settings to a data transfer card.
Set Up Serial Port 1 <sup>4</sup>	None, Visa with admit <sup>1</sup> , DIAP, Accutorr <sup>2</sup> , Gas Module, PatientNet <sup>1</sup>	None	Select to set up a serial output protocol port. An item enabled in SetUp Serial Port 1 will be removed from the selections in SetUp Serial Port 2.
Set Up Serial Port 2 <sup>4</sup>	None, Visa with admit <sup>1</sup> , DIAP, Accutorr <sup>2</sup> , Gas Module, PatientNet <sup>1</sup>	None	Select to set up a serial output protocol port. An item enabled in SetUp Serial Port 2 will be removed from the selections in SetUp Serial Port 1.
WMTS Enabled <sup>4</sup>	No, Yes	No	Set to "YES" to enable the use of the Panorama Instrument Radio - 608.

<sup>1</sup> "Visa with admit" and "PatientNet" will not be available as menu choices if "WMTS Enabled" is set to "Yes" or if "Enable Network" is set to "Wired" in the System Information menu.

<sup>2</sup> "Accutorr" will not be available as a menu choice if "WMTS Enabled" is set to "Yes"

<sup>3</sup> Country, language and system information are not affected by restoring defaults.

<sup>4</sup> Passport 2 only

<b>MENU TITLE ON SCREEN</b>	<b>MENU CHOICES</b>	<b>DEFAULT</b>	<b>ACTIONS/ COMMENTS</b>
Re-boot in demo mode	No, Yes	No	Set to "YES" to start the monitor in demonstration mode on next power-up. Normal monitoring will resume after cycling power in demonstration mode.
Restore factory defaults <sup>3</sup>			Select to restore factory defaults.
System Information			Select to set up owners screen.
Options			Select to add/view options.

*1 "Visa with admit" and "PatientNet" will not be available as menu choices if "WMTS Enabled" is set to "Yes" or if "Enable Network" is set to "Wired" in the System Information menu.*

*2 "Accutorr" will not be available as a menu choice if "WMTS Enabled" is set to "Yes"*

*3 Country, language and system information are not affected by restoring defaults.*

*4 Passport 2 only*

### 3.2.2 System Information Menu

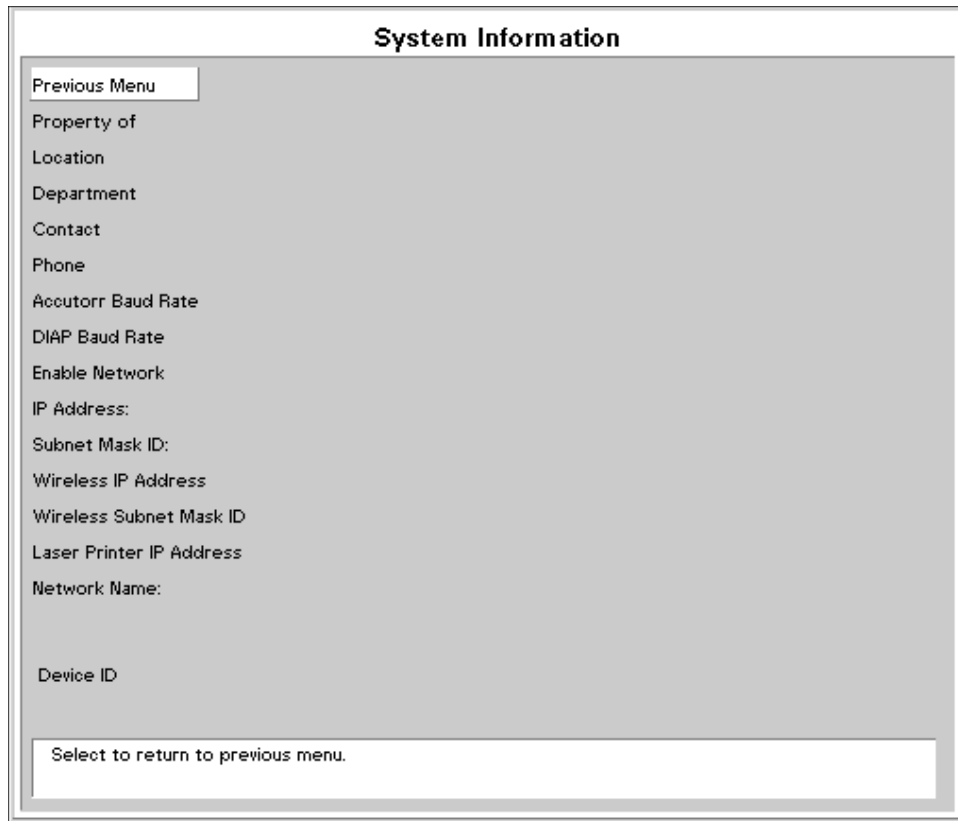

**FIGURE 3-2** System Information Menu

The System Information menu is accessed by rotating the cursor to the System Information selection on the Installation Menu and pressing the Navigator™ Control Knob. Each item on this screen is accessed in the same manner as the other menus on the monitor. Some items provide menu choices while others require information to be entered via a keypad-like entry screen. To enter information, rotate to the desired letter or number and then press the Navigator™ Control Knob to select. When finished, rotate to the Previous Menu tag and press the Navigator™ Control Knob. See the table that follows for descriptions of the System Information menu choices.

MENU TITLE ON SCREEN	MENU CHOICES	DEFAULT	TEXT STRINGS
Previous Menu			Select to return to Previous Menu
Property Of			Select to set up Property name
Location			Select to set up Location
Department			Select to set up Department
Contact			Select to set up Contact
Phone			Select to set up Phone
Accutorr Baud Rate <sup>5</sup>	1200, 9600	9600	Select to change the Accutorr protocol baud rate
DIAP Baud Rate <sup>5</sup>	9600, 19200	9600	Select to change the DIAP protocol baud rate
Enable Network <sup>1,5</sup>	No, Wired, Wireless <sup>2</sup>	No	Select to enable Panorama communications
IP Address: <sup>3,5</sup>			Select to set up IP Address
Subnet Mask ID: <sup>3,5</sup>			Select to set up Subnet Mask ID
Wireless IP Address <sup>3,5</sup>			Select to set up Wireless IP Address
Wireless Subnet Mask ID <sup>3,5</sup>			Select to set up Wireless Subnet Mask ID
Laser Printer IP Address <sup>5</sup>			Select to set up Laser Printer IP Address
Network Name: <sup>3,5</sup>			Select to set up Network name
Device ID <sup>4,5</sup>			

- 1 If a serial port is set to "Visa with admit" or "PatientNet", or if "WMTS Enabled" is set to "Yes" in the Installation Menu, "Enable Network" will not be available as a menu choice.
- 2 If "Wireless" is selected, the ability to enable 12-Lead ECG will be locked out of the Functions Menu.
- 3 Refer to the Panorama Service Manual for information on network settings.
- 4 Device ID is an information field that displays a unique, factory defined, device ID number. It is not user selectable.
- 5 Passport 2 only

## 3.3 Non-Invasive Blood Pressure Measurements (NIBP)

### 3.3.1 The NIBP Menu

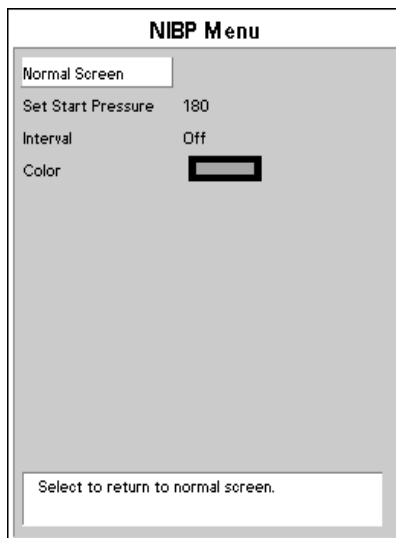

**FIGURE 3-3** NIBP Menu

### 3.3.2 Manual NIBP Measurements

1. Select a pressure cuff that is appropriate for the size of the patient. See Optional Accessories in Section 5.1 for a detailed list of available cuffs.

**NOTE:** A cuff that is too narrow for the limb will result in erroneously high readings. The correct size of the pressure cuff for a given patient has, among other considerations, a direct bearing on the accuracy of the obtained NIBP measurements. Base your selection of the cuff size on the limb circumference of the patient. The design dimensions of the cuffs and their intended uses are based on of the American Heart Association.

**NOTE:** Cuffs become brittle as they age and sometimes develop permanent folds that can leave temporary marks on the limb. Any cuffs that exhibit this effect should be replaced.

**NOTE:** Ensure that the pressure tubes are not compressed or restricted.

**NOTE:** The pressure on the limb may not fall to zero between measurements if the cuff is wrapped too tightly. Therefore, insure that the cuff is properly applied.

**NOTE:** The skin is sometimes fragile (i.e., on pediatrics, geriatrics, etc.). In these cases, a longer timer interval between measurements should be considered to decrease the number of cuff inflations over a period of time. In extreme cases, a thin layer of soft roll or cotton padding may be applied to the limb in order to cushion the skin when the cuff is inflated. This measure may affect NIBP performance and should be used with caution.

2. Attach cuff hose to NIBP Connector.
3. Apply the cuff to the patient. To reduce errors, the cuff should be fitted snugly, with little or no air present within the cuff. Be sure the cuff lies directly against the patient's skin. No clothing should come between the patient and the cuff.

**NOTE:**     **The NIBP cuff should not be placed on a limb that is being utilized for any other medical procedure. For example, an IV catheter or an SpO<sub>2</sub> sensor.**

4. If not already selected, select the Patient Size through the Patient Menu as described in Section 2.3. Choices are Adult, Pediatric or Neonate.
5. If necessary, change the initial cuff inflation pressure through the NIBP Menu.

Initial cuff inflation pressures depend on the patient size setting. The choices of cuff inflation are:

PATIENT SIZE SETTING	INITIAL CUFF INFLATION VALUES	DEFAULT SETTING	MAXIMUM INFLATION VALUES
Adult	100 - 280 mmHg	180 mmHg	300 mmHg
Pediatric	60 - 180 mmHg	140 mmHg	200 mmHg
Neonate	40 - 120 mmHg	100 mmHg	150 mmHg

6. Press **START** to begin an NIBP measurement.

**NOTE:**     **Inflate the cuff only after proper application to the patient's limb. Cuff damage can result if the cuff is left unwrapped and then inflated.**

The cuff begins to inflate to the selected cuff pressure. After reaching the selected value the cuff begins to slowly deflate and the Mindray DS **Passport 2/Passport 2 LT** Monitor collects oscillometric pulsations.

If the initial cuff inflation is found to be inadequate, the unit retries with a higher inflation pressure (+50 mmHg in the adult mode; +40 mmHg in the pediatric and neonate modes).

Have the patient remain still to avoid the introduction of unnecessary motion artifact. After the cuff pressure drops below the diastolic pressure, the results of the measurement are displayed.

If NIBP is the only parameter being measured with the **Passport 2/Passport 2 LT**, a heart rate can be derived from NIBP. The HR source menu selection must be in the Auto mode (i.e., not selected for ECG, IBP or SpO<sub>2</sub>) with no heart rate alarm limits set. (See Alarms Section 3.19 for details). If another heart rate source is available, the NIBP heart rate will be replaced by the heart rate from the selected source.

If NIBP is a selected trend source, then NIBP data will be recorded in the trend with the time stamp of the reading. If NIBP is not a selected trend source, then NIBP data will be recorded in the trend with the next entry into the trend caused by another trigger (i.e. Alarm, Interval Entry, or Mark Event key press). The time stamp will be that of the trigger causing the trend entry. (See Section 3.12 for details on trend triggers). The NIBP measurement and NIBP heart rate will be automatically removed from the display after a predetermined time interval. The NIBP timeout interval is 15 minutes by default and can be set to a different value through the Installation Menu.

### 3.3.3 Automatic NIBP Measurements

There are two modes available for automatic NIBP measurements. They are the Interval Mode and the Timer Mode. The Interval Mode allows you to set an interval that measurements will be taken. For example, if the interval is set to 10 minutes and the **START** key is pressed at 10:12, the measurements will be taken at 10:12, 10:22, 10:32, etc. The Timer Mode allows you to set an interval that is synchronized with the real time clock. For example, if the timer is set to 30 and the **START** key is pressed at 10:12, the measurements will be taken at 10:12, 10:30, 11:00, 11:30, etc.

Follow Steps 1 - 5 in Manual NIBP Measurement, Section 3.3.2.

7. Select the Interval Mode or the Timer Mode in the Monitor Setup menu.
8. Press **INTERVAL** until the desired time displays. The choices are: Off, Cont, 1 min, 2 min, 2.5 min, 3 min, 5 min, 10 min, 15 min, 20 min, 30 min, 1 hr, 2 hrs or 4 hrs.
9. Press **START** to begin taking interval measurements.

**NOTE:** If the monitor is in the interval mode when it is turned ON, no measurement will be taken until the **START** key is pressed.

**NOTE:** When the NIBP "continuous" interval is chosen, the Passport 2/Passport 2 LT will continually take back to back blood pressure readings. As a safety precaution, a limit is placed on continuous and 1 minute interval measurements. In continuous mode, after 5 minutes, the NIBP interval will automatically switch to one measurement taken every 5 minutes. In 1 minute mode, after 10 minutes the NIBP interval automatically switches to measurements taken once every 10 minutes.

#### 3.3.3.1 Automatic Adjustment in the Interval Mode

In the Interval mode, the unit adjusts the inflation pressure according to the previous reading of the systolic pressure. After the first measurement in the timer mode, the inflation pressure is the previous systolic +50 mmHg in the Adult Mode and +40 mmHg in the pediatric and neonate mode.

### 3.3.3.2 Suspension of NIBP Measurements

1. Press **STOP** to suspend an automatically timed measurement sequence or to end a measurement cycle already in progress (deflate cuff).
2. Press **START** to take an immediate measurement and resume a suspended timed measurement sequence.

**NOTE:** You can press **STOP** at any time to postpone a scheduled measurement or to terminate a measurement cycle already in progress.

**CAUTION:** Observe caution on all patients (Neonates, Pediatrics, and Adults) when NIBP is set to the Continuous Mode and the 1 minute interval. When the NIBP "continuous" interval is chosen, the Passport 2/Passport 2 LT will continually take back to back blood pressure readings. As a safety precaution, a limit is placed on continuous and 1 minute interval measurements. In continuous mode, after 5 minutes, the NIBP interval will automatically switch to one measurement taken every 5 minutes. In 1 minute mode, after 10 minutes the NIBP interval automatically switches to measurements taken once every 10 minutes. Reports have been made of nerve injury occurring during use of automatically cycled blood pressure cuffs. See the Appendix, "Cautions when Using Automatically Cycled Blood Pressure Cuffs".

### 3.3.4 NIBP Pressure Limit Fail Safe

If the cuff is over-pressurized, the cuff will automatically vent to atmosphere and the NIBP message window will alternately read "cuff over pressure" and "unable to measure". Power the system off and then on again.

### 3.3.5 Cuff Inflation Time

If the cuff pressure does not attain 20 mmHg within 40 seconds of the start of inflation or if the target pressure is not reached within another 60 seconds, then the cuff is vented and the "RETRY" or "UNABLE TO MEASURE" message will display in the NIBP message window.

### 3.3.6 START and STOP Functions

The START and STOP functions have the following effects on the timed measurement sequence (Interval or Timer Mode).

- **INTERVAL is set and you press START:**

An unscheduled measurement is made. Taking this unscheduled measurement does not affect the timing of the interval cycle, therefore, the scheduled measurements will be taken as if there were no interruptions. Only one measurement is taken for each measurement cycle - therefore, if the unscheduled measurement coincides with the scheduled measurement, it counts as the scheduled measurement.

- **INTERVAL is set and you press STOP during the measurement:**

The cuff deflates and interval measurements are suspended.

- **INTERVAL is set and you change the interval:**

The measurement cycle is reset with the new interval. A measurement will be taken after you press the **START** key.



### 3.3.7 NIBP Auto Time Out Functions

The NIBP Data will time out on the display under the following conditions:

- When the elapsed time exceeds the pre-set time out in the installation mode (See Section 3.2)
- If a measurement is unsuccessful, the display values are replaced with "XXX" and a tone sounds.

## 3.4 ECG Measurements

### 3.4.1 Electrocardiogram (ECG) Monitoring

ECG is a continuous waveform of a patient's cardiac electrical activity. The ECG waveform will display in the first waveform area of the **Passport 2/Passport 2 LT**.

The quality of an ECG signal is directly affected by electrode site skin preparation, electrode patch quality and ECG lead placement. If artifact is present on the ECG waveform, then the arrhythmia processing, alarm processing, and quality of the monitoring function may be affected. The presence of artifact can prevent the monitor from establishing an accurate ECG reference waveform, increasing the difficulty experienced in assessing the ECG rhythm.

Optimizing the ECG signal is imperative for accurate monitoring. Use high quality electrodes, designed to acquire the ECG with excellent base line stability, recovery from defibrillation and minimum artifact from patient movement.

With the **Passport 2**, ECG can be obtained by using a 3 Lead, 5 Lead or 12 Lead ECG cable in conjunction with a lead set and skin electrodes. With the **Passport 2 LT**, ECG can be obtained by using a 3 Lead or 5 Lead ECG cable in conjunction with a lead set and skin electrodes. For best performance and safety, inspect the ECG cables and electrodes daily.

**WARNING:** Ensure that the conductive parts of ECG electrodes do not contact other conductive parts, including earth ground.

**CAUTION:** To avoid possible damage to the Passport 2/Passport 2 LT, use only ECG cables and accessories available from Mindray DS.

**CAUTION:** Line Isolation Monitor transients may resemble actual cardiac waveforms, thus inhibiting heart rate alarms. Check leadwires for damage and ensure good skin contact prior to and during use. Always use fresh electrodes and follow proper skin preparation techniques.

**NOTE:** This device is not intended for direct cardiac application.

#### 3.4.1.1 Skin Preparation

Proper skin preparation is essential in obtaining an accurate ECG reading. Electrode sites should be clean and dry and should provide a smooth flat surface. Incidental electrical activity and inaccurate readings may arise from incorrect skin preparation.

The following procedure is recommended for secure electrode patch application:

1. Shave the chest hair from the electrode sites in a circular area with a diameter of 2 – 4 inches.
2. Use a dry gauze pad to remove excess skin oils, skin cells and residue from the electrode sites. Never rub the skin until it is raw or bleeding.

**NOTE:** Prepare the electrode site with alcohol only if the skin is extremely greasy. If alcohol is used as a drying agent, always allow the skin to dry before placing the electrode patch on the skin.

### 3.4.1.2 Electrode Patch Location

**NOTE:** Store electrode patches at room temperature and open just prior to use.

**NOTE:** Avoid more than one type of electrode on a patient because of variations in electrical resistance.

**NOTE:** Avoid placing electrode patches directly over bone prominences or over any high activity movement areas such as shoulders or arms because muscle motion produces electrical activity. If an electrode patch is placed over a large muscle such as the pectorals, the monitor may detect this additional muscle activity and could lead to false arrhythmia calls.

1. To prevent evaporation of the contact gel medium, peel the backing off of the electrode patch only when it is ready for use. Visually inspect the contact gel medium for moistness. If the gel medium is not moist, do not use the electrode patch. Dry electrode patches are not conductive.

**NOTE:** If using the snap type electrode wires, attach the electrode patch to the leadwire before placing patch on the patient.

2. Attach the electrode patch to the skin at the prepared site. Smooth the electrode patch down in a circular motion to ensure proper skin contact. If using soft gel electrodes, never push down directly over the contact gel medium as this may displace the gel and cause monitoring artifact. If using hard gel electrodes, it is recommended that during application, the center of the electrode should be slightly pressed onto the skin to ensure direct contact. Consult the electrode patch manufacturer's instructions for specific use.
3. Secure the leadwires to the patient according to hospital practice. For additional information see section 3.4.1.3, "Lead Placement".

**WARNING:** Ensure that the ECG leadwires are neatly secured in a manner that will prevent them from encircling the patient's neck, creating a strangulation hazard.

**NOTE:** It is recommended that electrode patches be changed at least every 24 – 36 hours to maintain proper contact with the skin. Some patients may require electrodes to be changed more often. Electrode patches are disposable and should be applied only once. Try to avoid reusing the exact same electrode site during reapplication. If an electrode becomes wet with fluid, change the electrode patch.

### 3.4.1.3 Lead Placement

The computerized arrhythmia algorithm works best when the patient's R wave is significantly larger than the P wave or the T wave. If the R wave is not significantly larger than other lower voltage waves on the ECG tracing, the computer may have some difficulty in identifying the appropriate waves. On some patients, electrode patch placement and/or the viewed ECG lead may need to be adjusted in order to obtain a significant R wave.

This section outlines lead placement according to the guidelines of the American Heart Association (AHA).

## Standard 3-wire Lead Sets

A 3-wire lead set can monitor one of three ECG vectors (I, II, or III). The recommended 3-wire lead placement is as follows.

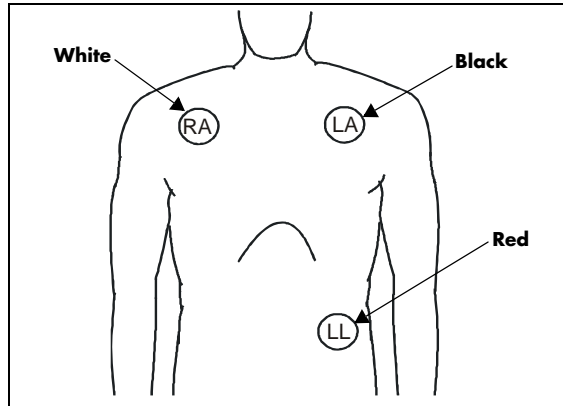
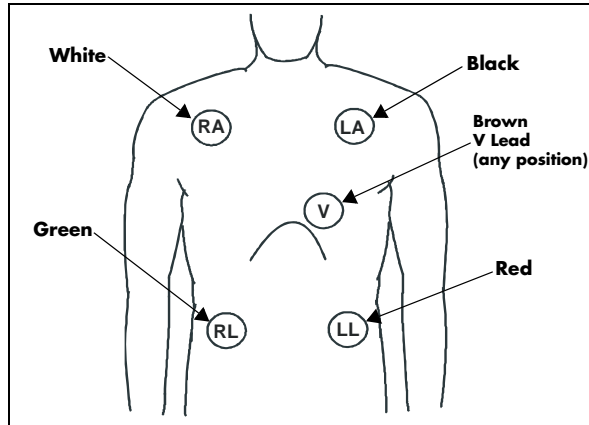

**FIGURE 3-4** 3-wire Lead Placement (AHA)

- Place the RA (white) electrode under the patient's right clavicle, at the mid-clavicular line within the rib cage frame.
- Place the LA (black) electrode under the patient's left clavicle, at the mid-clavicular line within the rib cage frame.
- Place the LL (red) electrode on the patient's lower left abdomen within the rib cage frame.

## Standard 5-wire Lead Sets

A 5-wire lead set can monitor seven ECG vectors (I, II, III, aVR, aVL, aVF, and V) simultaneously. The recommended 5-wire lead placement is as follows.

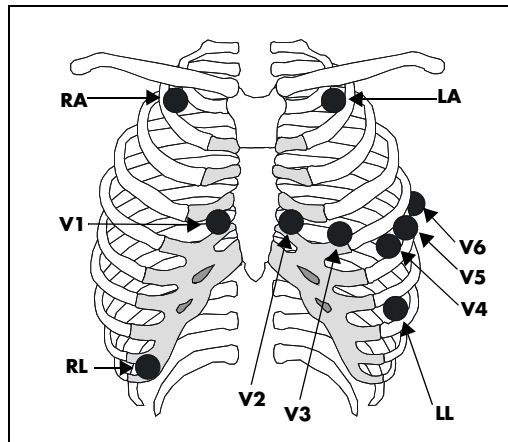

**FIGURE 3-5** 5-wire Lead Placement (AHA)

- Place the RA (white) electrode under the patient's right clavicle, at the mid-clavicular line within the rib cage frame.
- Place the LA (black) electrode under the patient's left clavicle, at the mid-clavicular line within the rib cage frame.
- Place the LL (red) electrode on the patient's lower left abdomen within the rib cage frame.
- Place the RL (green) electrode on the patient's lower right abdomen within the rib cage frame.
- Place the V (brown) electrode in one of the V-lead positions (V1 – V6) depicted in the following section.

## View 12™ Card (Optional Passport 2)

A View 12™ card utilizes a 10-wire ECG lead set that can monitor 12 ECG vectors (I, II, III, aVR, aVL, aVF, V1, V2, V3, V4, V5, and V6) simultaneously. The recommended lead placement for a View 12™ card is as follows.

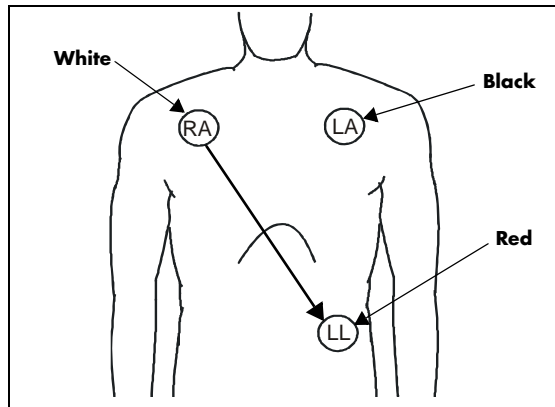

**FIGURE 3-6** View 12™ Card Lead Placement (AHA)

- Place RA (white) electrode under the right clavicle, mid-clavicular line within the rib cage frame.
- Place LA (black) electrode under the left clavicle, mid-clavicular line within the rib cage frame.
- Place LL (red) electrode on the lower left abdomen within the rib cage frame.
- Place RL (green) electrode on lower right abdomen within the rib cage frame.
- Place V1 (brown) chest lead in the fourth intercostal space, right sternal border.
- Place V2 (brown) chest lead in the fourth intercostal space, left sternal border.
- Place V3 (brown) chest lead midway between V2 and V4 on a straight line.
- Place V4 (brown) chest lead in the fifth intercostal space, mid-clavicular line.
- Place V5 (brown) chest lead in the fifth intercostal space, anterior axillary line.
- Place V6 (brown) chest lead in the fifth intercostal space, mid-axillary line.

## Lead II Monitoring

The recommended lead placement for Lead II monitoring is as follows.



**FIGURE 3-7** Lead II Monitoring (AHA)

- Place the RA (white) electrode under the patient's right clavicle, at the mid-clavicular line within the rib cage frame.
- Place the LA (black) electrode under the patient's left clavicle, at the mid-clavicular line within the rib cage frame.
- Place the LL (red) electrode on the patient's lower left abdomen within the rib cage frame.

Select ECG Lead II on the monitor. Lead II is the direct electrical line between the RA (white) electrode and the LL (red) electrode.

## Modified Chest Lead (MCL) Monitoring

The recommended lead placement for MCL monitoring is as follows.

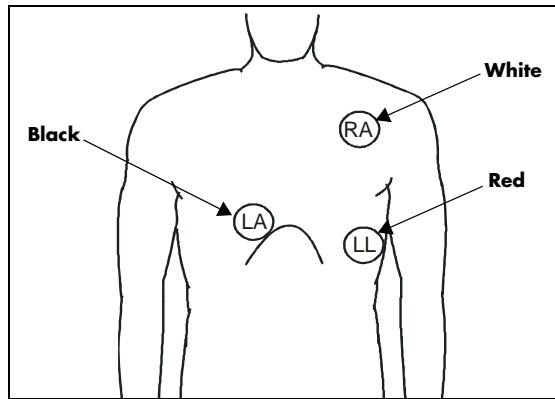

**FIGURE 3-8** MCL Monitoring with a 3-wire Lead Set (AHA)

- Place the RA (white) electrode under the patient's left clavicle, at the mid-clavicular line within the rib cage frame.
- Place the LA (black) electrode on the right sternal border, at the fourth intercostal space within the rib cage frame.
- Place the LL (red) electrode on the patient's lower left abdomen within the rib cage frame.

Select ECG Lead I for MCL<sub>1</sub> monitoring. Lead I is the direct electrical line between the RA (white) electrode and the LA (black) electrode.

Select ECG Lead II for MCL<sub>2</sub> monitoring. Lead II is the direct electrical line between the RA (white) electrode and the LL (red) electrode.



## Neonatal Electrode Placement

Using a 3-wire lead set, ECG lead placement on a neonate is usually directed towards obtaining the best possible respiration data through the ECG thoracic impedance technique. Thoracic impedance is usually measured between the Right Arm and Left Arm electrode patches. These patches should be placed on the chest directly across from each other to optimize the measuring of the neonate's chest movement. The recommended lead placement for neonate monitoring is as follows.

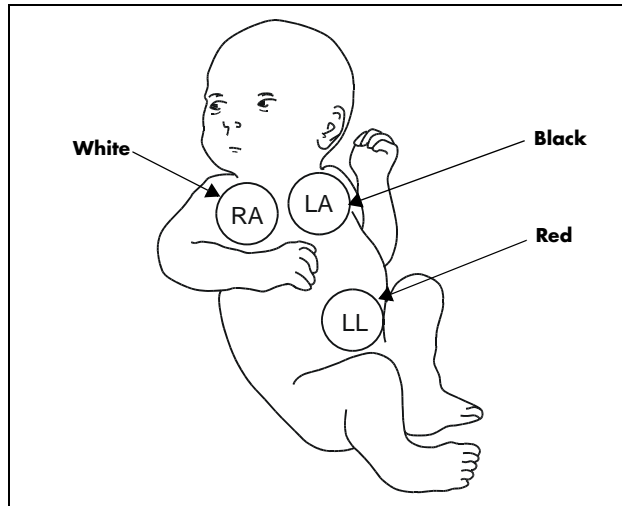
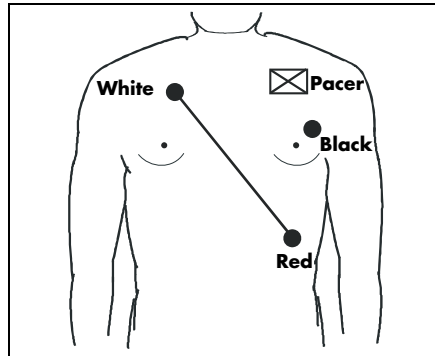

**FIGURE 3-9** Neonatal 3-wire Lead Placement (AHA)

- Place the RA (white) electrode under the patient's right clavicle, at the mid-clavicular line within the rib cage frame.
- Place the LA (black) electrode under the patient's left clavicle, at the mid-clavicular line within the rib cage frame.
- Place the LL (red) electrode on the patient's lower left abdomen within the rib cage frame.

## Monitoring a Pacemaker Patient

The recommended lead placement for monitoring a pacemaker patient is as follows.



**FIGURE 3-10** 3-wire Lead Placement for a Pacemaker Patient (AHA)

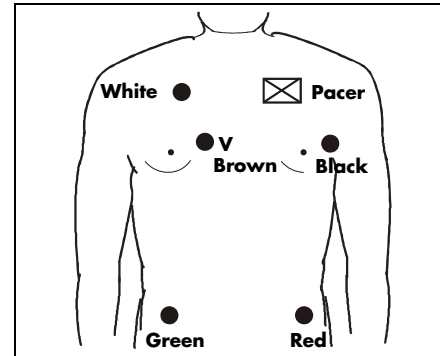

**FIGURE 3-11** 5-wire Lead Placement for a Pacemaker Patient (AHA)

A pacemaker patient usually requires a different electrode patch placement configuration than a non-pacemaker patient.

Do not place an ECG electrode directly over the pacemaker generator. Place the electrode patches 3 – 5 inches away from the pacemaker generator area. For example, if the pacemaker generator is located in the right subclavian area, relocate the Right Arm (white) electrode closer in towards the center of the chest.

**WARNING:** Pacemaker patients' rate meters may continue to count the pacemaker rate during occurrences of cardiac arrest or some arrhythmias. Do not rely entirely upon rate meter alarms. Keep pacemaker patients under close surveillance. See the Appendix section of this manual for disclosure of the pacemaker pulse rejection capability of this instrument.

**CAUTION:** Some pacemakers may contain a respiratory sensor that may produce artifact on an ECG waveform.

## Using a Transcutaneous Electrical Nerve Stimulator (TENS)

Since a TENS unit transmits electrical impulses, avoid placing ECG electrode patches near the TENS electrodes. ECG electrode patches may need to be repositioned and the ECG lead viewed may need to be adjusted until the optimum ECG tracing is obtained.

## 3.4.2 The ECG Menu

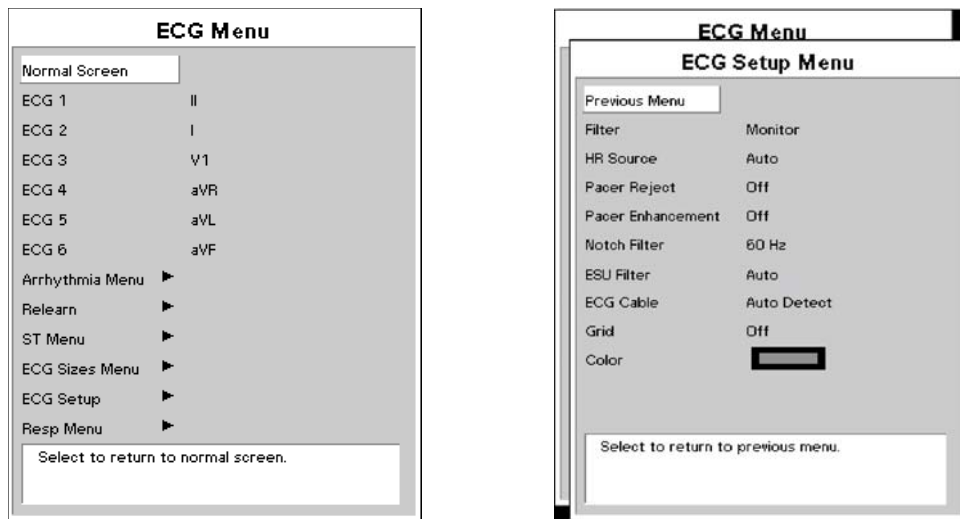

**FIGURE 3-12** ECG Menu

The **ECG Menu** provides the following choices: **Normal Screen**, **ECG 1 – ECG 6**, **Arrhythmia Menu**, **Relearn**, **ST Menu**, **ECG Sizes Menu**, **ECG Setup** and **Resp Menu**.

- The **Normal Screen** selection returns the view to the normal screen.
- The **ECG 1 – ECG 6** selections define the ECG labels for printing and trends.
- The **Arrhythmia Menu** selection opens the **Arrhythmia Menu**.
- The **Relearn** selection is only available if the ST or Arrhythmia options are installed and is used to manually initiate the learning process for ST measurements or Arrhythmia analysis.
- The **ST Menu** selection opens the **ST Menu**.
- The **ECG Sizes Menu** selection opens the **ECG Sizes Menu**.
- The **ECG Setup** selection opens the **ECG Setup Menu** that is detailed in the following table.
- The **Resp Menu** selection opens the **Resp Menu**.

### ECG Setup Menu

MENU ITEM	SELECTIONS	FACTORY DEFAULT/COMMENTS
Previous Menu		Returns to the previous menu.
Filter	Monitor, Extended, ST	Select to change the filter mode for ECG. Extended or ST must be used for ST analysis. The filter setting affects both the display output and the printer output.  Monitor = 0.5 - 40 Hz Extended, 3 or 5-lead = 0.05 - 100 Hz Extended, 12-lead = 0.05 - 150 Hz ST = 0.05 - 40 Hz

**ECG Setup Menu (Continued)**

<b>MENU ITEM</b>	<b>SELECTIONS</b>	<b>FACTORY DEFAULT/COMMENTS</b>
HR Source	Auto, ECG, <IBP1 Label>, <IBP2 Label>, <IBP3 Label>, <IBP4 Label>, SpO <sub>2</sub>	Dependent on current settings, the IBP Label selections may remain as numbered or may be substituted with one of the following: Art, PA, CVP, ICP, RA, UA, LV, LA, IABP.
Pacer Reject	On, Off	When set to On, pacers are eliminated from the display.
Pacer Enhancement	On, Off	When set to On, all detected pacemaker spikes are displayed.
Notch Filter	Off, 50 Hz, 60 Hz	This menu item is used to filter out AC line noise from the ECG waveform. The Off selection is not saved with the Save Current function and will be reset when the monitor is power cycled.
ESU Filter	Auto, Disable	This menu item is used to filter out high frequency electrosurgical noise from the ECG waveform. The Disable selection is not saved with the Save Current function and will be reset when the monitor is power cycled. This function is not supported in 12 lead mode.
ECG Cable	Auto Detect, 3 lead, 5 lead	This menu item is used to manually set the mode of operation for the chosen ECG cable type.  <b>NOTE:</b> When using Mindray DS cables, the Auto Detect selection will automatically detect the cable type and switch the mode of operation accordingly.
Grid	On, Off	Select to turn the ECG grid On or Off.
Color	List of 16 colors	Select to change the display color for all ECG waves and for the HR and ST parameters.

## 3.4.3

**3 Lead or 5 Lead ECG Measurements**

**NOTE:** If an electro-surgical device is to be used on the patient, use the ESIS cable. Respiration from ECG is not available if the ESIS cable is used.

1. Plug patient cable into the ECG connector. An ECG waveform will be present on the screen. The heart rate appears to the right of the waveform.
2. Select desired lead setting by pressing the front panel **ECG LEAD** key. Lead II is automatically selected at power-up.
3. Select desired ECG size by pressing the front panel **ECG SIZE** key. An ECG of 1 cm/mV is automatically selected at power-up.
4. If cascaded ECG is desired in waveform 2, use the Monitor Setup menu (see section 2.3.2), to choose this option.
5. If desired, choose an alternative source for heart rate. Choices are: ECG, IBP1, IBP2, SpO<sub>2</sub>, or AUTO. AUTO selects the source from a hierarchy (ECG, IBP1, IBP2, SpO<sub>2</sub>, NIBP) of what is currently monitored.

**CAUTION:** To assure successful triggering of Intra-Aortic balloon pump from the Passport 2/Passport 2 LT monitor, set the "ECG Filter" to "Extended" and set "Pacer Enhancement" to "On". Both of these settings are located in the ECG setup menu of the Passport 2/Passport 2 LT.

**CAUTION:** The Analog Output on the Passport 2/Passport 2 LT supports triggering the Intra-Aortic Balloon Pump (IABP) for 3 Lead and 5 Lead ECG cable monitoring only. Invasive Blood Pressure triggering is not supported. ECG analog output is disabled when 12 Lead ECG analysis is enabled.

### 3.4.4 “ECG Lead Fault” Message

A lead fault message will be displayed if an ECG lead becomes disconnected from the patient.

A “CHECK LEAD CONNECTION” message will be displayed if 3 lead or 5 lead ECG has an intermittent or poor connection. See section 3.4.1.1 for proper skin preparation for electrode placement.

**NOTE:** If a 3 or 5 Lead ECG cable and the View 12™ ECG Analysis Module are both in use, and 12 Lead ECG is enabled, then “Lead Fault” messages refer to the 12 Lead cable only.

**NOTE:** When monitoring 12-Lead ECG, a “Lead Fault” message will not be displayed if RL (Right Leg lead) becomes disconnected from the patient.

### 3.4.5 12-Lead ECG Monitoring (Optional Passport 2)

This feature is added to the **Passport 2** by inserting the View 12™ ECG Analysis Module into slot PCM 1 on the right side of the monitor.

All **Passport 2** monitors used with a View 12™ ECG Analysis Module on a hardwired Panorama Central Station must comply with the following software requirements. Failure to do so may cause inaccurate information to be printed at the Panorama Central Station laser printer.

- Panorama software version 8.1.6 requires **Passport 2** software version W.18
- Panorama software version 8.2 or higher requires **Passport 2** software version W.28 or higher

**WARNING:** The View 12™ ECG Analysis Module is not intended for use during electrosurgery. If the electrosurgical ground connection is not satisfactory, there exists a possibility of patient burns at the ECG electrode sites.

1. Prep patient’s skin as indicated in Section 3.4.1.1 prior to placement of electrodes. See View 12™ Card (Optional Passport 2) on page 3-17. for proper electrode placement.
2. Insert View 12™ ECG Analysis Module with cable attached into PCM slot 1 on right side of **Passport 2**, turn monitor on.
3. To enable 12-Lead (if function is disabled), with the 12-Lead card inserted into PCM slot 1, go to the Functions menu and select “Enable 12-Lead ECG” using the Navigator Control Knob.
4. To view multiple leads of ECG, press the **VIEW** key. Press the **VIEW** key once to view the first 6 ECG leads, press again to view another 6 leads. Pressing a third time will return to normal viewing.

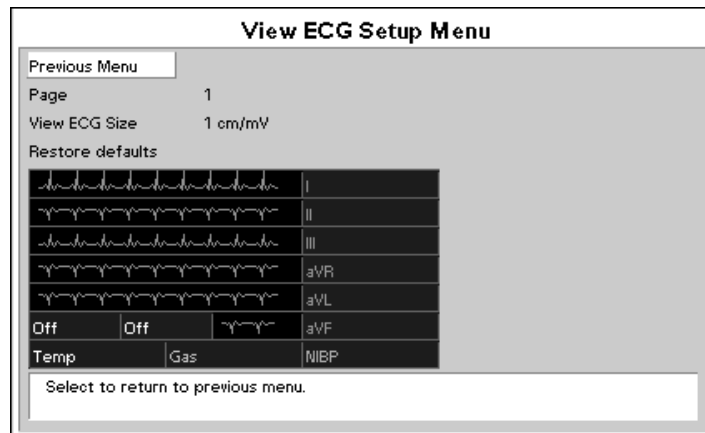

5. Select desired leads to view in the View ECG Setup menu within the Monitor Setup menu.
6. To change sizes of displayed waveforms, go to the ECG Sizes Menu within the ECG menu.
7. To remove the View 12™ ECG Analysis Module, turn monitor off or go to the Functions menu and select "Disable 12 Lead ECG", then use the Navigator Control knob to select "Yes".

**CAUTION: Removal of the View 12™ ECG Analysis Module without first disabling the 12-Lead ECG card may cause a temporary disruption in patient monitoring.**

### 3.4.5.1 12-lead ECG Analysis (Optional Passport 2)

With a View 12™ ECG Analysis Module installed and enabled, the **Passport 2** is capable of providing ECG Analysis on printouts. To print this analysis, press the **VIEW** key (to view multiple ECG leads), then press **STRIP**. If all conditions for analysis have been met, the recorder will include it on the printed strip. The analysis will consist of an interpretive statement, a condition statement, and a rhythm statement as specified in the Physician's Guide to Computerized ECG Analysis (Mindray DS P/N 0070-00-0524-01 English, 0070-00-0524-50 all other languages).

The conditions for printing the ECG analysis are:

1. The **Passport 2** patient size must be set to "Adult".
2. The patient's gender and date of birth must be entered via the Patient menu.
3. The patient must be at least 18 years old. (The monitor calculates the patient age from the date of birth entered.)

**WARNING: Computerized ECG Analysis should be reviewed by qualified medical personnel. It should not be used exclusively for treatment or non-treatment of patients.**

**WARNING: ST segment measurements may be affected by one or more of the following ECG rhythm morphologies: wide complex QRS such as bundle branch blocks, ventricular pacemaker rhythm, left ventricular hypertrophy or Wolff-Parkinson-White Syndrome. Consult with qualified medical personnel prior to treatment or non-treatment.**

## 3.5 Invasive Blood Pressure (IBP1, IBP2) (optional Passport 2)

1. Plug the pressure transducer into the PRESSURE TRANSDUCER connector on the left side panel.
2. To establish a monitoring site, introduce an arterial pressure catheter into the patient's artery in accordance with standard hospital procedures. "Best practice," as determined by the medical community, should be observed.

**NOTE:**        **The arterial pressure catheter should not be used on a limb that is being utilized for any other medical procedure. For example, an IV Catheter or an SpO<sub>2</sub> sensor.**

3. Connect catheter line with flushing device to the pressure transducer.
4. Zero pressure transducer as follows:
  - a. Open transducer vent to atmosphere.
  - b. Press **ZERO ALL**.

After the automatic zero process is complete, the pressure display should indicate zeros.

**NOTE:**        **If the transducer offset should exceed 120 mmHg, it will not be possible to automatically zero the transducer. Pressure values will be xxx and an "UNABLE TO ZERO" message will be displayed.**

5. Close the pressure transducer vent from atmosphere.
6. The IBP1 waveform will appear by default as the fourth waveform on the display with its associated data to the right of the waveform. The waveform may be displayed in another location or turned off by accessing the "Display Setup" menu. The IBP2 waveform and/or data will not appear unless a location has been designated in the "Display Setup" menu.
7. Select the desired pressure scale in the IBP Menu.
8. Flush arterial line at regular intervals per standard hospital procedure.

**NOTE:**        **Pressure transducers are protected against the effects of defibrillation and electrocautery.**

## 3.6 SpO<sub>2</sub> Pulse Oximetry

### 3.6.1 SpO<sub>2</sub> Menu

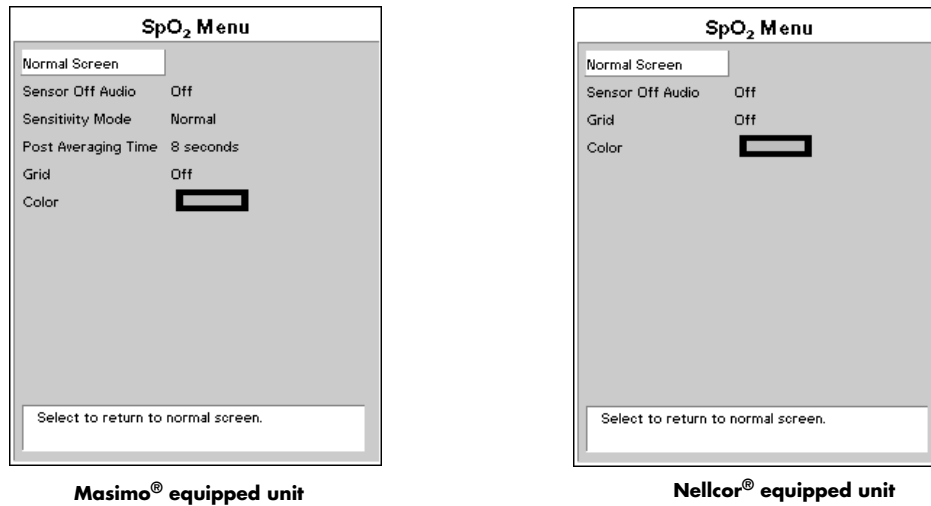

**FIGURE 3-13** SpO<sub>2</sub> Menus

### 3.6.2 SpO<sub>2</sub> Measurements

1. Select the appropriate sensor for the patient.
2. Attach the SpO<sub>2</sub> Patient Cable to the sensor and plug the other end of the patient cable into the SpO<sub>2</sub> connector located on the left side panel of the monitor.

**NOTE:** Do not place the sensor on an extremity with an IV catheter or blood pressure cuff in place.

**NOTE:** Ensure proper routing of patient cable to avoid entanglement and/or strangulation.

**CAUTION:** When equipped with Masimo® SpO<sub>2</sub>, use only Masimo oxygen transducers including Masimo LNOP® patient dedicated adhesive sensors and Masimo PC Series Patient Cable. Use of other oxygen transducers may cause improper oximeter performance.

**CAUTION:** When equipped with Nellcor® SpO<sub>2</sub>, use only Nellcor oxygen transducers including Nellcor Oxisensor® and OxiMax® patient dedicated adhesive sensors. Use of other oxygen transducers may cause improper oximeter performance.

**CAUTION:** Tissue damage or inaccurate measurements may be caused by incorrect SpO<sub>2</sub> sensor application or use, such as wrapping it too tightly, applying supplemental tape, failing to inspect the sensor site periodically, or failing to position it appropriately. Carefully read the sensor directions for use, the Passport 2/Passport 2 LT operating instructions, and all precautionary information before use.



- CAUTION:** Excessive ambient light may cause inaccurate measurements. In such cases, cover the SpO<sub>2</sub> sensor site with opaque material.
- CAUTION:** Inaccurate measurements may be caused by incorrect SpO<sub>2</sub> sensor application or use; significant levels of dysfunctional hemoglobins, (e.g., carboxyhemoglobin or methemoglobin); or intra-vascular dyes such as indocyanine green or methylene blue; exposure to excessive illumination, such as surgical lamps (especially ones with a xenon light source), bilirubin lamps, fluorescent lights, infrared heating lamps, or direct sunlight; excessive patient movement; venous pulsations; electro-surgical interference; and placement of a sensor on an extremity that has a blood pressure cuff, arterial catheter, or intra-vascular line.
- CAUTION:** In certain situations in which perfusion and signal strength are low, such as in patients with thick or pigmented skin, inaccurately low SpO<sub>2</sub> readings will result. Verification of oxygenation should be made, especially in preterm infants and patients with chronic lung disease, before instituting any therapy or intervention.
- CAUTION:** Many patients suffer from poor peripheral perfusion due to hypothermia, hypovolemia, severe vasoconstriction, reduced cardiac output, etc. These symptoms may cause an inability to acquire physiological data.
- CAUTION:** The site should be checked at least every eight (8) hours (every four (4) hours with the Adult re-usable SpO<sub>2</sub> finger sensor). Ensure proper adhesion, skin integrity, and proper alignment. Nail polish and fungus may affect readings. Exercise extreme caution with poorly perfused patients. Skin erosion and pressure necrosis can be caused when sensors are not frequently monitored. Assess the site every two (2) hours with poorly perfused patients.
- CAUTION:** If the SpO<sub>2</sub> sensor or patient cable is damaged in any way, discontinue use immediately. To prevent damage do not soak or immerse the sensor in any liquid solution. Do not attempt to sterilize.
3. The Pleth waveform and digital SpO<sub>2</sub> value will be displayed by default in the second waveform and parameter area.
  4. Enter the display set-up menu as described previously in this manual, to display Pleth waveform and data in an alternative location.
  5. Set the "Sensor -Off Audio", in the SpO<sub>2</sub> menu to the desired setting. Set to **OFF**, the **Passport 2/Passport 2 LT** will not give an audio beep when the SpO<sub>2</sub> sensor is off the patient. Set to "ON", the **Passport 2/Passport 2 LT** will sound a series of 5 triple beeps.
  6. Color - menu selectable, multi-color.
  7. Grid - menu selectable On or Off.
  8. Masimo<sup>®</sup> Sensitivity Mode and Post Average Time
- Passport 2/Passport 2 LT** monitors equipped with Masimo SpO<sub>2</sub> allow the user to adjust Sensitivity and Post Averaging Time. The user should choose the sensitivity mode depending upon signal quality and patient motion. In most cases, the normal setting will be appropriate. If the patient motion is limited, high sensitivity can be used.

It is also possible to change the averaging time of the Saturation and Pulse Rate measurements. The post average time can be changed to 6, 8, 10, 12, 14 or 16 seconds.

### 3.6.3 Performance Considerations

To ensure optimal performance, use an appropriate sensor, apply it as directed, and observe all warnings and cautions.

If excessive ambient light is present, cover the sensor site with opaque material. Failure to do so may result in inaccurate measurements. Light sources that can affect performance include surgical lights, especially those with a xenon light source, bilirubin lamps, fluorescent lights, infrared heating lamps, and direct sunlight.

In the event that you are unable to get any reading, or the reading you get is inaccurate, consider the following:

- If your patient is poorly perfused, try applying the sensor to another site - such as a different finger or toe.
- Check that the sensor is properly aligned.
- In electrosurgery, make sure sensor is not too close to ESU devices or cables.
- Check to make sure the site area is clean/non-greasy. Clean site and sensor if needed. Nail polish and fungus should be removed.

#### 3.6.3.1 Calibration

The oximetry sub-system incorporates automatic calibration mechanisms. No other calibration is required.

#### 3.6.3.2 Auto Scaling

The Pleth waveform is automatically scaled. There is no adjustment that can be made to the Pleth waveform size.

### 3.6.4 Masimo<sup>®</sup> Sensors and Patient Cable

Masimo provides a family of sensors suitable for a wide variety of clinical settings and patients. Specific sensors have been developed for neonates, infants, children, and adults. All sensors are:

1. indicated for continuous non invasive monitoring of arterial oxygen saturation (SpO<sub>2</sub>) and pulse rate
2. non-sterile
3. usable during patient movement

The LNOP<sup>®</sup>•DCSC Adult Reusable Spot Check Sensor is used for "spot check" applications. The LNOP<sup>®</sup>•DCI Adult Re-usable Finger Sensor can also be used for "spot check" applications if needed. All sensors are intended for "single-patient use only" unless indicated as "reusable".

### 3.6.4.1 Masimo Sensors and Accessories

#### Masimo Sensors Family

<b>SELECTION</b>	<b>PART NUMBER</b>	<b>PATIENT SIZE</b>	<b>DISPOSABLE/ REUSABLE</b>
LNOP <sup>®</sup> •Adt Adult Disposable Finger Sensor	0600-00-0043-01	> 30 kg.	Disposable
LNOP <sup>®</sup> •Pdt Pediatric/Slender Digit Disposable Sensor	0600-00-0044-01	10 to 50 kg.	Disposable
LNOP <sup>®</sup> •Neo Neonatal Disposable Sensor	0600-00-0045-01	< 10 kg.	Disposable
LNOP <sup>®</sup> DC-12 Adult Finger Sensor	0600-00-0120	> 30 kg.	Re-usable
LNCS <sup>™</sup> Adtx Adult Adhesive Sensors	0600-00-0121	> 30 kg.	Disposable
LNCS <sup>™</sup> Pdtx Pediatric Adhesive Sensors	0600-00-0122	10 to 50 kg.	Disposable
LNCS <sup>™</sup> Inf-L Infant Adhesive Sensors	0600-00-0123	3 to 20 kg.	Disposable
LNCS <sup>™</sup> Neo-L Neonatal Adhesive Sensors	0600-00-0124	> 40 kg.	Disposable
LNCS <sup>™</sup> NeoPt –L Neonatal PreTerm Adhesive Sensors	0600-00-0125	< 1 kg.	Disposable
LNCS <sup>™</sup> DC-I Adult Reusable Sensor	0600-00-0126	> 30 kg.	Re-usable
LNCS <sup>™</sup> DC-IP Pediatric Reusable Sensor	0600-00-0127	10 to 50 kg.	Re-usable
LNOP <sup>®</sup> •Neo Pt Neonatal Pre-term Disposable Sensor	0600-00-0046-01	< 1 kg.	Disposable
LNOP <sup>®</sup> •DCI Adult Reusable Finger Sensor	0600-00-0047	> 30 kg.	Re-usable
LNOP <sup>®</sup> •DCSC Adult Reusable Spot Check Sensor	0600-00-0077	> 30 kg.	Re-usable
LNOP <sup>®</sup> •YI Multisite Reusable Sensor	0600-00-0078	> 1 kg.	Re-usable
LNOP <sup>®</sup> •EAR Reusable Ear Sensor	0600-00-0079	> 30 kg.	Re-usable
LNC-4, Patient Cable, 4 feet)	0012-00-1652	All	Re-usable
LNC-10, Patient Cable, 10 feet	0012-00-1599	All	Re-usable
LNC-14, Patient Cable, 14 feet	0012-00-1653	All	Re-usable
LNCS <sup>™</sup> Series to LNOP <sup>®</sup> PC Series, Patient Cable	0012-00-1651	All	Re-usable
Masimo SET <sup>®</sup> AC-1 Adapter Cable	0012-00-1656	All	Re-usable
PC Series Patient Cable	0012-00-1099-02	All	Re-usable

### 3.6.4.2 Selecting a Sensor

Sensors are designed for specific sites on patients with designated weight ranges. To select the appropriate sensor, consider the patient's weight, level of activity, adequacy of perfusion, which sensor sites are available and the anticipated duration of monitoring.

### 3.6.4.3 Cleaning and Re-use

The sensor may be reattached to the same patient if the emitter and detector windows are clear and the adhesive still adheres to the skin. The adhesive can be partially rejuvenated by wiping with an alcohol wipe and allowing the sensor to thoroughly air dry prior to replacement on the patient.

## 3.6.5 Nellcor<sup>®</sup> Sensors and Patient Cable

Nellcor provides a family of sensors suitable for a wide variety of clinical settings and patients. Specific sensors have been developed for neonates, infants, children, and adults. Oxisensor<sup>®</sup> and OxiMax<sup>®</sup> oxygen transducers are sterile adhesive sensors with optical components mounted on adhesive tape. Oxiband<sup>®</sup> oxygen transducers are reusable sensors that are applied with disposable adhesive. The Durasensor<sup>®</sup> DS-100A adult digit oxygen transducer is a reusable sensor with its optical components mounted in a plastic casing. The Nellcor RS-10 and Max-Fast<sup>®</sup> oxygen transducers are adhesive sensors for application to forehead or temple.

All Nellcor accessories and sensors must be purchased from Nellcor Puritan Bennett Inc. To contact Nellcor Puritan Bennett Inc., call 1-800-635-5267.

### 3.6.5.1 Selecting a Sensor

Sensors are designed for specific sites on patients with designated weight ranges. To select the appropriate sensor, consider the patient's weight, level of activity, adequacy of perfusion, which sensor sites are available, whether sterility is required, and the anticipated duration of monitoring.

Only Nellcor<sup>®</sup> oxygen transducers should be used with the **Passport 2** or **Passport 2 LT** monitors with Nellcor<sup>®</sup> Oxismart<sup>®</sup> or OxiMax<sup>®</sup> pulse oximetry.

### 3.6.5.2 Cleaning and Re-Use

Do not immerse any Oxisensor<sup>®</sup>, OxiMax<sup>®</sup>, Durasensor<sup>®</sup> or Oxiband<sup>®</sup> oxygen transducers, the Nellcor<sup>®</sup> RS-10 or Max-Fast<sup>®</sup> oxygen transducers, or any Nellcor<sup>®</sup> adhesive in water or cleaning solution. Clean Durasensor<sup>®</sup> and Oxiband<sup>®</sup> oxygen transducers, and the Nellcor<sup>®</sup> RS-10 or Max-Fast<sup>®</sup> oxygen transducers by wiping with a disinfectant such as 70% alcohol. Do not sterilize by irradiation, steam, or ethylene oxide. Use a new Oxiband<sup>®</sup> adhesive wrap or FORM-A adhesive bandage for each patient. Do not re-sterilize Oxisensor<sup>®</sup> or OxiMax<sup>®</sup> oxygen transducers.

## 3.7 ST Monitoring (Optional Passport 2)

ST Analysis is available for Adult and Pediatric patients only.

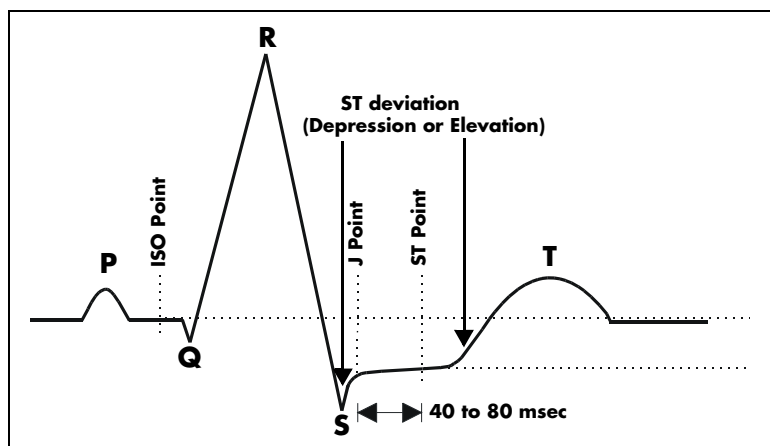

**FIGURE 3-14** ST Monitoring

The depression or elevation of the ST segment is measured as the vertical distance between the isoelectric (ISO) point which provides the baseline, and the ST point (see Figure 3-11). ST measurements are available on a maximum of three user selected ECG leads at a point situated 80 msec (heart rate 120 bpm or less) or 60 msec (heart rate more than 120 bpm) from the algorithmically determined end point of the QRS (J Point). In addition, the user can also select from three (3) different settings for the ST measurement point (80, 60, or 40 ms) from the J-point and independent of heart rate. These measurements are valid only on normal beats. Abnormal beats, like ventricular beats, are excluded from the analysis of ST segment. Ventricular paced beats are also rejected from the analysis of the ST segment, because pacer tails distort the shape of the ST segment.

ST segment changes are continuously measured by the monitor, but update of the displayed ST data is different depending on the ECG cable in use. When using a 3 or 5 lead ECG cable, the displayed ST data is updated approximately every 10 seconds.

**NOTE:**     **The ST algorithm has been tested for accuracy of the ST segment data. The significance of the ST segment changes must be determined by a clinician.**

The **Passport 2** initiates the Learning process for ST measurements after one of the following:

- Unit Power-Up
- Return to normal monitoring from Standby mode
- Enabling ST analysis
- The lead has been changed in ECG 1 waveform (3 lead only)
- Patient Size is Changed
- Whenever the "Relearn" function is selected from the ST, ECG or Arrhythmia Menus.

It is recommended that a Relearn be initiated after one or more of the following:

- ECG electrodes have been repositioned
- Eight hours have passed since the last Relearn
- Any significant changes to the patient QRS complex
- The observed ST measurement mode has been changed (Delta or Absolute - 12 Lead only)
- A clinician has observed clinically questionable arrhythmia calls

A Relearn must be initiated if "Learning" occurred during a "Leads Off" condition.

### 3.7.1 ST Setup

Select the waves to be used for ECG. ST analysis is performed on the leads chosen as ECG 1, ECG 2 and ECG 3 on the ECG Menu. ST analysis begins when the feature is turned on from the ST Menu. By default, ST data will appear in the Heart Rate Tile.

To display the ST data in the second tile, set waveform 2 to display any ECG wave (i.e. ECG2, ECG3, or ECG1 Cascade), then set "Combine ST/HR" to OFF.

Once waveform 2 has been set to display an ECG wave, the learned ST patterns or ST trend data may be displayed in place of the ECG wave.

Set "View ST" to "Minitrends" to view the trended data for each analyzed lead. Set "View ST" to "Averaged ST" view the learned and current ST complex for each analyzed lead.

When View 12™ ECG Analysis Module is installed, continuous 12-lead ST monitoring will be enabled when "ST analysis" is set to "On". 12-lead ST analysis may be viewed in 2 modes: Delta and Absolute. Delta ST is the ST segment change between the learned ST segment and the present ST segment. Absolute ST is the ST segment change between the "O" baseline point of the ST and the present ST segment.

To display 12-lead ST data in a tile, set Waveform 2 to display any ECG wave, ST minitrends or Averaged ST.

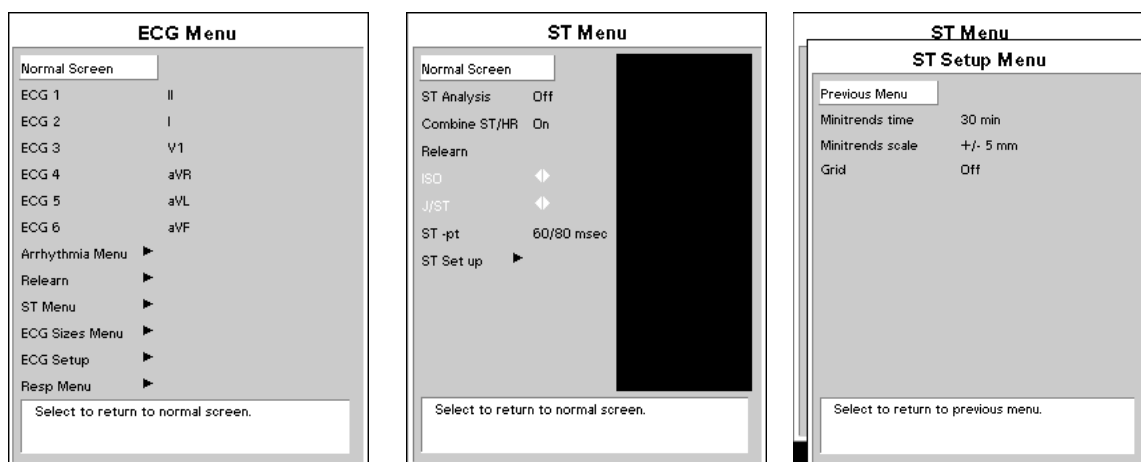
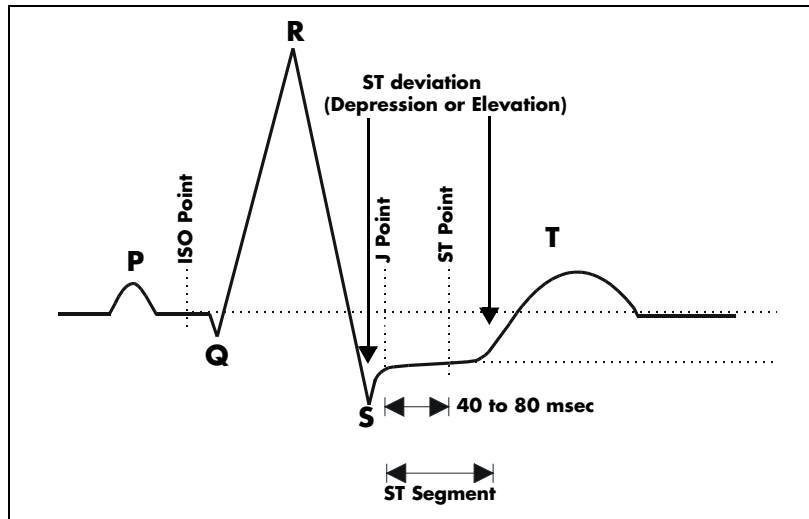

**FIGURE 3-15** ST Setup (3/5 lead)

## 3.8 Arrhythmia Algorithm (Optional Passport 2)

The **Passport 2** uses an arrhythmia algorithm to monitor ECG waveform data. The algorithm creates ECG waveform templates based on a patient's normal ECG data and uses them to analyze newly received data. The algorithm verifies that data is free from noise and artifact, and that it does not deviate from the patient's normal ECG rhythms.

A normal ECG waveform typically includes consistent spacing between R waves, a sharp and well defined QRS complex, and an ECG baseline that is free of noise and artifact.



**FIGURE 3-16** Sample Waveform

### Noise and Artifact

The presence of noise or artifact in an ECG waveform makes the accurate detection and classification of heart beats difficult. To best optimize performance, all leads should be free of noise.

Some of the causes of ECG noise include poor skin preparation, improperly attached electrodes, dried electrode gel, defective leadwires, and patient movement. The algorithm uses several techniques to differentiate a patient's QRS complexes from noise sources.

If noise levels are too high, the following will occur until the signal quality is re-established:

- Beat detection is suspended
- All rhythm calls are suspended
- An **ECG Noise** message is displayed when ECG noise is detected in one or more ECG leads. If ECG noise continues beyond the configured noise delay, an alarm is triggered, and ECG rhythm analysis is stopped.

## Heart Rate Meter

Heart Rate is computed using the 16 most recent R-R intervals for heart rates above 48 beats per minute. If the rate calculated using the last 4 beats is less than 48 beats per minute, then this rate is used. All detected beats are used to compute the heart rate. A separate ventricular rate is used in the algorithm to determine rhythms like ventricular tachycardia and ventricular run.

## Filtering Pacer Signals

In order to prevent pacer pulses from being mistaken for QRS complexes, they are removed from the ECG data that is sent to the arrhythmia algorithm for analysis. Pacer pulses are shown on the **Passport 2** as exaggerated vertical lines.

## ECG Amplitude

The QRS detection threshold algorithm setting is fixed between 0.15 and 0.45 mV to avoid detecting noise spikes or P-waves as valid beats. Changing the display gain on the monitor does not affect the signal that is used by the algorithm for beat detection. For optimal performance, the leads selected for monitoring should have an amplitude of 0.5 to 1 mV or more.

## Learning

The process of learning is used to establish a normal beat template for a patient. The learn period is dependent on the heart rate and the dominant pattern. Learning should not be initiated during a primarily ventricular rhythm because an ectopic beat may be established as normal.

A learn should be initiated when beats are not being properly detected, or when they are being erroneously classified. However, if a signal is not strong enough, or lead data is extremely noisy, better signal quality must be established before a learn can be effective.

## Beat Detection and Typing

The following table describes the leads that are used to measure beat detection and beat typing.

DESCRIPTION	3-WIRE LEAD SET	5-WIRE LEAD SET	VIEW 12™ CARD
Leads used for Beat Detection	Determined by viewed lead	II and V	V1 and V5
Leads used for Beat Typing	Determined by viewed lead	II, V, and I	V1, V5, and II
Leads used for V-Fib Detection	Determined by viewed lead	II and V	V1 and V5

The search for the next beat begins after a refractory period to avoid detecting T- waves as valid QRS complexes. For all patient sizes, the minimum QRS amplitude that can be detected is between 0.15 and 0.45 mV depending on the width of the QRS complexes.

Beat typing aligns and compares each new heart beat to reference templates that were previously stored in the system. A beat typing algorithm classifies the beats.



- If an incoming beat matches a template that has already been classified, it is given the same label as the template. The template parameters are updated with the features from this new beat.

The real time ECG analysis library incorporates ventricular ectopic beat detection as a part of arrhythmia analysis.

- Beats are measured for compensatory pause, QRS width, QRS positive and negative areas, and R wave positive and negative amplitudes. This process uses multiple leads when available.
- A scoring algorithm is then applied to those measurements to determine whether or not a beat is ectopic.

## 3.9 ST Segment Analysis (Optional Passport 2)

The ST segment of an ECG waveform (shown in FIGURE 3-16) represents the period from the end of ventricular de-polarization, to the beginning of ventricular re-polarization, or the end of the QRS complex (the J point) and the beginning of the T-wave. ST Segment analysis is used to monitor the oxygen supply and the viability of the heart muscle.

ST deviation is the vertical distance between the isoelectric (ISO) point level and signal level at ST point. The ST point is located 40 to 80 milliseconds beyond the J-point.

The ISO point is located between the end of the P-wave and the onset of the QRS complex. The ISO point provides the baseline for this measurement.

The ST point is a fixed distance from the J point at the end of the QRS complex. The ST point can be configured to 40, 60, or 80 milliseconds past the J-point, independent of the heart rate. By default, the ST point is positioned as follows:

- at 80 milliseconds for heart rates less than or equal to 120 beats per minute
- at 60 milliseconds for higher heart rates

ST data is calculated on the averaged beat, and not on individual beats. The reliability of ST measurements is lowered with the presence of atrial fibrillation, flutter, and erratic baseline changes.

All available ECG leads are analyzed to measure deviations in the ST segment.

### Learning

The process of learning is used to establish normal beat templates or a stable baseline for accurate ST analysis. To establish this baseline, the system evaluates the first sixteen normal beats based on readings from leads I, II and V.

To establish an accurate baseline, it is recommended that learning be done when the patient is in stable condition, not moving, and has an ECG rhythm that is free of artifact. Learning should not be initiated during a primarily ventricular rhythm or other ECG rhythm irregularity because an ectopic beat may be established as normal.

### ECG Filters

The ST segment of an ECG waveform often contains low amplitude signals with low frequency content. To preserve low frequency signal content, the high pass filter is set to 0.05 Hz when ST analysis is turned on.

## 3.10 Arrhythmia Alarms (Optional Passport 2)

Arrhythmia alarms are activated based on the patterns in the patient ECG waveform rhythms. Beat detection for a 5-wire lead set is determined by using a combination of leads II and V. When using a 3-wire lead set, beat detection is determined by using the lead being viewed.

The following lethal and non-lethal arrhythmia alarms may be detected by the arrhythmia algorithm.

**NOTE:** Arrhythmia alarms are not available for the Neonate patient size.

### 3.10.1 Lethal Arrhythmia Alarms

A lethal arrhythmia is an arrhythmia that can be life threatening to a patient if left untreated. Ventricular Tachycardia (V-Tach), Ventricular Fibrillation (V-Fib), and Asystole alarms are classified as lethal arrhythmia alarms. These alarms automatically default to Alarm Priority 1.

**NOTE:** Lethal arrhythmia alarms are latched alarms. Even after the alarming condition is resolved, a latched alarm will continue until it is acknowledged by pressing the MUTE or MUTE ALL key on the front panel keypad. If the alarm is acknowledged while the lethal condition still exists, the audio portion of the alarm will be muted for the duration that is selected from the "Mute For" list in the "Alarm Setup" menu, but the alarm message will remain in message area A. If a new lethal condition occurs while the initial lethal alarm is muted, the new lethal alarm will not break through and will be muted for the remainder of the mute duration. If the lethal condition is resolved while the alarm is muted, the alarm will be terminated.

#### Asystole Alarm

An **Asystole** alarm is activated when no QRS complexes are detected for the configured time period in the absence of Ventricular Fibrillation.

For 3-Lead and 5-Lead ECG – The time period range for an **Asystole** alarm is user selectable from 3 to 10 seconds.

For 12-Lead ECG – The time period range for an **Asystole** alarm is user selectable from 3 to 8 seconds.

The Asystole alarm is a Priority 1 alarm event that produces:

- Alarm Priority 1 visual and audio alarm indicators.
- An **Asystole** text message above the ECG1 waveform area.

#### Ventricular-Fibrillation (V-FIB) Alarm

A **V-FIB** alarm is activated when a fibrillated waveform (P, QRS or T waves can no longer be identified) is detected. V-FIB is defined as "irregular, disorganized electrical activity of the heart". The V-FIB detection algorithm runs in parallel to the beat detection algorithm and continuously examines the incoming data.

The V-FIB alarm is a Priority 1 alarm event that produces:

- Alarm Priority 1 visual and audio alarm indicators.
- A **V-FIB** text message above the ECG1 waveform area.

### Ventricular Tachycardia (V-TACH) Alarm

A **V-TACH** alarm is activated when a set number of consecutive PVCs is reached at a rate exceeding the set V-TACH rate.

- The V-TACH rate may be set between 100 and 180 beats per minute.
- The number of consecutive PVCs may be set between 3 and 15 beats.

A V-TACH alarm is a Priority 1 alarm event that produces:

- Alarm Priority 1 visual and audio alarm indicators.
- A **V-TACH** text message above the ECG1 waveform area.

## 3.10.2

### Non-Lethal Arrhythmia Alarms

A Non-Lethal Arrhythmia is an arrhythmia that is most likely not life threatening to a patient. Bigeminy, Bradycardia, Couplet, Irregular Heart Rate, Pause, PVC/min, Run, Trigeminy, and Ventricular Rhythm (V-Rhythm) alarms are classified as non-lethal arrhythmia alarms.

**NOTE:** **Non-lethal arrhythmia alarms are not latched alarms and can be acknowledged at any time. To acknowledge a non-lethal arrhythmia alarm, press the MUTE key on the keypad.**

### Bigeminy Alarm

The **Bigeminy** alarm is activated when three or more cycles of one PVC coupled to one normal beat are detected.

The Bigeminy alarm is a Priority 2 alarm event that produces:

- Alarm Priority 2 visual and audio alarm indicators.
- A **BIGEMINY** text message above the ECG1 waveform area.

### Bradycardia (Brady) Alarm

The **Brady** alarm is activated when the heart rate falls to a value 10% lower than the user selected value for low heart rate alarm.

**NOTE:** **The Bradycardia alarm is not available when using a View 12™ card.**

The **Brady** alarm is an alarm event that produces:

- Alarm Priority 1 visual and audio alarm indicators.
- A **Brady** text message above the ECG1 waveform area.

### Couplet Alarm

The **Couplet** alarm is activated when two consecutive PVCs are detected between normal beats.

The Couplet alarm is a Priority 2 alarm event that produces:

- Alarm Priority 2 visual and audio alarm indicators.
- A **COUPLET** text message above the ECG1 waveform area.

## Irregular Heart Rate Alarm

The **Irregular Heart Rate** alarm is activated when the measured variations in the R-R interval over a period of time exceeds a preset limit established by the arrhythmia algorithm.

**NOTE:**        **The Irregular Heart Rate alarm is not available when using a View 12™ card.**

The Irregular Heart Rate alarm is a Priority 2 alarm event that produces:

- Alarm Priority 2 visual and audio alarm indicators.
- An **IRREGULAR HR** text message above the ECG1 waveform area.

## Pause Alarm

The **Pause** alarm is activated when no beat is detected during an interval that is greater than 1.8 R-R and the next beat is not a PVC.

**NOTE:**        **The Pause alarm is only available when using a View 12™ card.**

The **Pause** alarm is a Priority 2 alarm event that produces:

- Alarm Priority 2 visual and audio alarm indicators.
- A **PAUSE** text message above the ECG1 waveform area.

## PVC/minute Alarm

The PVC alarm is activated when the number of PVCs detected per minute exceeds the configured threshold. The PVC limit can be set to Off, or 1 to 30 PVCs per minute.

The PVC alarm has priority settings of **1** or **2**, and behaves as follows:

- If the High PVC alarm priority is set to **1**, Alarm Priority 1 visual and audio alarm indicators are produced.
- If the High PVC alarm priority is set to **2**, Alarm Priority 2 visual and audio alarm indicators are produced.

**NOTE:**        **PVC/min will not be displayed during periods of Ventricular Rhythms, V-TACH, V-FIB and Asystole.**

## Run Alarm

The **Run** alarm is activated when the number of consecutive PVCs occur at a rate that equals or exceeds the user defined V-Tach Rate. The number of consecutive PVCs that constitute a Run is one beat less than the minimum used to identify V-Tach.

The Run alarm is a Priority 2 alarm event that produces:

- Alarm Priority 2 visual and audio alarm indicators.
- A **RUN** text message above the ECG1 waveform area.

### Trigeminy Alarm

The **Trigeminy** alarm is activated when three or more cycles of one PVC coupled to two normal beats are detected. This rhythm could also cause an Irregular HR alarm.

- The Trigeminy alarm is a Priority 2 alarm event that produces:
- Alarm Priority 2 visual and audio alarm indicators.

A **TRIGEMINY** text message above the ECG1 waveform area.

### Ventricular Rhythm (V-Rhythm) Alarm

The **V-Rhythm** alarm is activated when more than 2 consecutive PVCs occur at a rate that is less than the user defined V-Tach Rate.

The V-Rhythm alarm is a Priority 2 alarm event that produces:

- Alarm Priority 2 visual and audio alarm indicators.
- A **VENTRICULAR RHYTHM** text message above the ECG1 waveform area.

## 3.11 Arrhythmia Analysis (Optional Passport 2)

**WARNING:** The arrhythmia analysis feature is intended to detect ventricular rhythms, however, due to physiologic differences in patient populations, the Passport 2/Passport 2 LT may occasionally sound a false alarm or may not recognize some arrhythmia patterns.

The **Passport 2** is capable of identifying ventricular arrhythmia patterns in Adult and Pediatric size patients. Arrhythmia analysis may be enabled or disabled via the Arrhythmia Menu. By default, arrhythmia analysis is enabled.

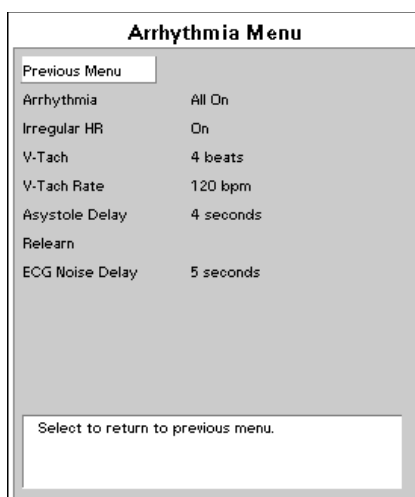

**FIGURE 3-17** Arrhythmia Menu (3/5 lead)

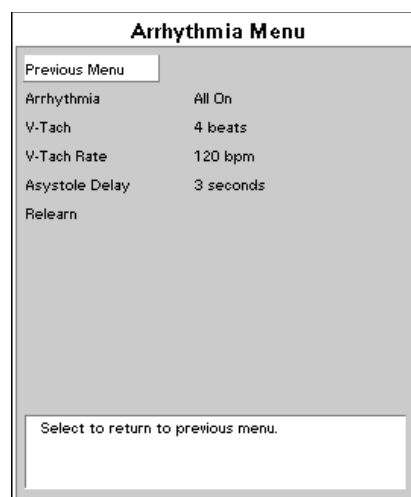

**FIGURE 3-18** Arrhythmia Menu (12 lead)

Arrhythmia alarm calls are classified as Priority 1 or Priority 2.

Asystole, Ventricular Tachycardia, Ventricular Fibrillation and Bradycardia are classified as Priority 1 and the priority level cannot be changed by the user. In addition, these alarms will sound continuously until the user presses the **MUTE** or **MUTE ALL** key, regardless of whether the patient's condition has improved.

The other arrhythmia alarms are classified as Priority 2 by factory default. The characteristics and priority level of the "PVC/min" alarm can be changed at the user's discretion via the Alarm Limits Setup menu.

The following alarm calls can be made when Arrhythmia Analysis is set to "All On" (default setting):

- Asystole, Ventricular Tachycardia, Ventricular Fibrillation, Ventricular Rhythm, Run, PVC/Min, Couplet, Bigeminy, and Trigeminy.

For 3-lead or 5-lead ECG, the following additional calls can be made:

- Irregular HR and Bradycardia

For 12-lead ECG, the following additional call will be made:

- Pause

The following alarm calls will be made when Arrhythmia analysis is set to "Non-lethals Off":

- Asystole, Ventricular Tachycardia, and Ventricular Fibrillation.

When Arrhythmia analysis is set to "All Off", no arrhythmia alarm calls will be made.

The **Passport 2** initiates the Learning process for Arrhythmia measurements after one of the following:

- Unit Power-Up
- Return to normal monitoring from Standby mode
- Enabling Arrhythmia analysis
- The lead has been changed in ECG 1 waveform (3 lead only)
- Patient Size is Changed
- Whenever the "Relearn" function is selected from the ST, ECG or Arrhythmia Menus.

It is recommended that a Relearn be initiated after one or more of the following:

- The ECG electrodes have been repositioned
- Sufficient time has passed since the last Relearn
- Any significant changes to the patient QRS complex
- Any significant changes to the patient ECG rhythm
- A clinician has observed clinically questionable arrhythmia calls

A Relearn must be initiated if "Learning" occurred during a "Leads Off" condition.



## 3.12 Temperature Menu

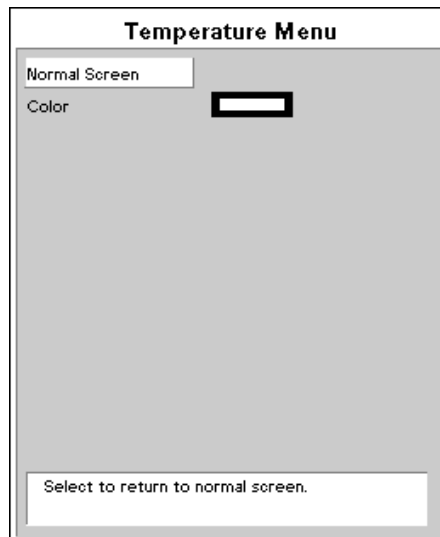

**FIGURE 3-19** Temperature Menu

The Temperature measurement function of the **Passport 2/Passport 2 LT** is designed to take temperature readings from YSI 400 or YSI 700 or compatible probes. To display the Temp Menu, turn the Navigator™ Control Knob to the Parameters tile along the top of the screen. Rotate the Navigator Control Knob to highlight the Temperature selection. Press the Navigator Control Knob and the Temperature Menu will appear.

### 3.13 List Trends (Passport 2 Only)

List Trend								
Normal Screen	Time	SpO <sub>2</sub> %	IBP1 mmHg	IBP2 mmHg	T1 °F			
Scroll	17:48	---	-14/ 50(150)	---/ --- (---)	98.7			
Event	17:48	95	---	---	98.7			
Clear Trends	17:54	97	110/ 60 (80)	110/ 60 (80)	100.1			
Graph Trend	17:53	98	110/ 60 (80)	110/ 60 (80)	99.3			
Setup	17:51	↑	110/ 60 (80)	110/ 60 (80)	98.7			
	17:50	100	-14/ 50(150)	-14/ 50(150)	100.1			

Select to return to normal screen.

**FIGURE 3-20** List Trends

The List Trend display allows the user to view a tabular list of stored patient vital signs and anesthetic gas data. Press the **TRENDS** key to access this display. A maximum of 120 time-stamped entries may be stored. If the "Extended Trend" option is installed, a maximum of 500 time-stamped entries may be stored. When the maximum number of entries has been reached, the oldest entry will be deleted from the trend record in order to allow storage of a new entry.

The left side of the List Trend display contains menu items for scrolling, setup, and access to other displays. Trend data is listed from newest to oldest. Use the Vertical Scroll feature to view older data. Use the Horizontal Scroll feature to view all the columns of data.

**NOTE:** When scrolling horizontally, the first column of data remains displayed and does not scroll.

Scroll bars along the right and bottom sides of the trend display indicate the position of viewed data in relation to the rest of the database. Upon reopening of the trend screen, the last viewed data position will be displayed at the top of the trend screen.

The leftmost column of the List Trend display contains markers which indicate if the entry was triggered by an alarm violation or **MARK EVENT** keypress. On color displays these markers are red for priority 1 alarms, yellow for priority 2 alarms, and green for **MARK EVENT** keypresses. On monochrome displays these markers are bold for priority 1 alarms, half-brightness for priority 2 alarms, and normal brightness for **MARK EVENT** keypresses.

Trend data in violation of an alarm is also highlighted according to the priority of the alarm. On color displays this data is red for priority 1 alarms and yellow for priority 2 alarms. On monochrome displays this data is bold for priority 1 alarms and half-brightness for priority 2 alarms.

If data for a parameter was not available at the time of the trend entry, the data field will be dashed. If an NIBP reading could not be obtained or an invasive pressure channel was not zeroed at the time of the trend entry, the data field will contain "xxx".

### 3.13.1 Modification of Parameters Displayed

The parameters displayed always include the currently active parameters and any others used since the time the patient was "admitted" to the monitoring system. The default order of parameters displayed from left to right is: HR, NIBP, SpO<sub>2</sub>, Resp, CO<sub>2</sub>, IBP1, IBP2, T1, O<sub>2</sub>, Agent, N<sub>2</sub>O, and PVC. To change the order of the parameters displayed, select "Setup" from the List trend menu. Once in the Setup Menu, change the Format selection from "Auto" to "Manual". The parameters to be displayed in each of the first 6 columns may then be specified.

### 3.13.2 Modification of Trend Entry Conditions

Trend entry conditions may be modified via the Advanced Setup Menu. The Advanced Setup Menu is accessed from the Monitor Setup Menu. Any combination of Trend Input triggers may be used.

TREND ENTRY TRIGGER	DEFAULT	COMMENT
Interval	Off	Trend entries will occur at the selected time interval
Alarm	Off	Trend entries will occur when an alarm violation occurs
NIBP	On	Trend entries will occur whenever an NIBP measurement is made

Pressing the **MARK EVENT** key will always cause a Trend entry.

### 3.13.3 Filtering of List Trend Data Displayed

Data corresponding to **MARK EVENT** keypresses will always be included in the displayed data. If the Trend Entry Triggers for Alarms and/or NIBP have been set to "On", this data will also always be included.

Trend entries triggered by the Interval setting above may be filtered out from the displayed List trend data. To change the amount of interval entries displayed, select "Setup" from the List trend menu. Once in the Setup Menu, select "Display Interval" and set as desired. The choices available for the "Display Interval" depend on the setting of the "Trend Entry Interval" setting above. (If the "Trend Entry Interval" is set to "Off", there will be no choices available for "Display Interval".)

**NOTE:** If the "Display Interval" remains set to "Off" while the "Trend Entry Interval" has been set to something other than "Off", the trend may appear to clear itself or to have disappeared. This is because the trend has reached its maximum number of entries and new interval data (although not displayed) is causing older trend entries to be deleted from the database.

### 3.13.4 Printing List Trend Data

To print, press the **PRINT TREND** key while the List Trend is displayed. The recorder will print the data for all parameters from the first line displayed to the last line of the trend record. Use the Vertical Scroll feature to position the first line to be printed at the top of the List Trend display. Press the **PRINT TREND** key again to stop printing at any time.

### 3.13.5 Transferring List Trend Data Between Different Passport 2 Monitors

List and Graph Trend data, along with patient name and demographics may be transferred between **Passport 2** monitors with a "Mindray DS Transfer Card" (P/N 0996-00-0051-01).

1. Insert the Transfer Card into the PCM2 slot on the right side of the source monitor.
2. Access the Functions Menu of the source monitor, and select "Copy patient data to card" from the menu. A status message will report completion of the transfer. (This section is grayed-out if a transfer card is not plugged into the PCMCIA slot A.)
3. Remove the card and insert it into the PCM2 slot of the receiving monitor.
4. Access the Functions menu of the receiving monitor, and select "Copy patient data from card". A status message will report completion of the transfer.

### 3.13.6 Transfer Notes

1. If the source monitor is equipped with the "Extended Trend" option and the receiving monitor is not, only the latest 120 trend entries will be transferred from the card.
2. If the latest trend data stored on the card has a time stamp newer than the time displayed on the receiving monitor, data transfer will be prohibited. (This is possible when the time and date settings on the monitors have not been correctly set.)

### 3.13.7 Clearing Trend Data

To manually clear all trend data, including Graph and OXY CRG trends, choose "Clear Trends" from the menu. A confirmation prompt will appear. Once cleared, the data cannot be restored.

All trend data is automatically cleared when the patient is "discharged" from the monitor.

All trend data is also cleared if the monitor's displayed time or date is changed.

### 3.13.8 Removing the List Trend Display

The List Trend display does not automatically "time-out" and must be manually removed to return to the normal waveform display. To remove the Trend display, choose "Normal Screen" from the menu, or press the **NORMAL SCREEN** key.

## 3.14 Graph Trends (Passport 2 Only)

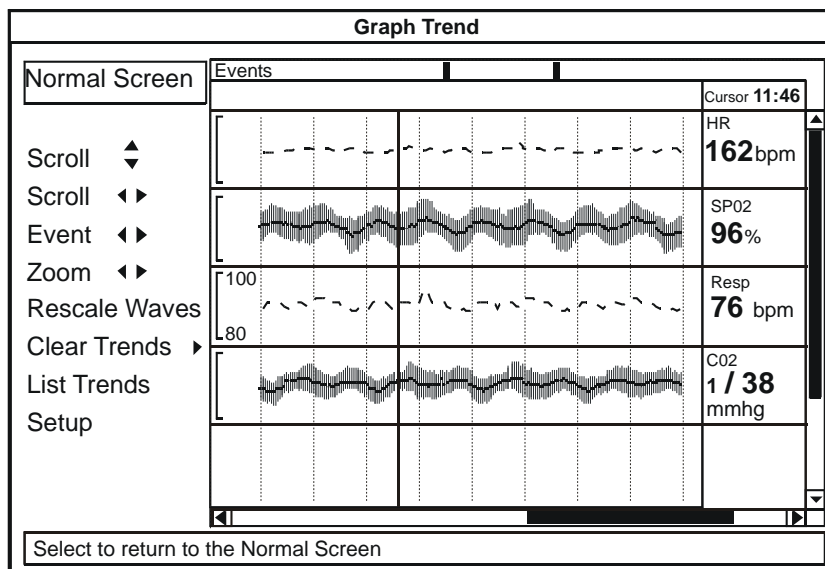

**FIGURE 3-21** Graphing Trends

The Graph Trend display allows the user to view a graphic summary of stored patient vital signs and anesthetic gas data. To access this display from the normal monitoring screen, press the **TRENDS** key twice. To access this display from the List Trends display, press the **TRENDS** once. This display may also be accessed from the other trend displays via menu selection.

The left side of the Graph Trend display contains menu items for scrolling, setup, and access to other displays. The Graph Trend data window contains up to 4 parameter displays. Use the Vertical Scroll feature to view other parameters.

**NOTE:** When scrolling vertically, the topmost parameter remains displayed and does not scroll.

Time stamps are included at the top of the window, with the most recent data appearing at the right end. Use the Horizontal Scroll feature to move the cursor through time. Scroll bars along the right and bottom sides of the trend display indicate the position of viewed data in relation to the rest of the database. The Event Scroll feature may be used to scroll quickly between events (caused by Alarm entries and **MARK EVENT** key presses).

The Rescale Waves feature automatically rescales the viewed parameters' graphs so all data is displayed. The Zoom feature may be used to adjust the amount of time shown in the trend window.

The top line of the Graph Trend display contains markers which indicate if the entry was triggered by an alarm violation or **MARK EVENT** keypress. On color displays these markers are red for priority 1 alarms, yellow for priority 2 alarms, and green for **MARK EVENT** keypresses. On monochrome displays these markers are bold for priority 1 alarms, half-brightness for priority 2 alarms, and normal brightness for **MARK EVENT** keypresses.

As the cursor is scrolled horizontally, the digital data corresponding to the points in the graph is shown at the right side of the window. Trend data in violation of an alarm is highlighted according to the priority of the alarm.

On color displays:

- Priority 1 alarm data is shown in inverse video with red background.
- Priority 2 alarm data is shown in inverse video with yellow background.

On monochrome displays:

- Priority 1 alarm data is shown in inverse video with background at full brightness.
- Priority 2 alarm data is shown in inverse video with background at half brightness.

If data for a parameter was not available at the time of the trend entry, the data field will be dashed. If an NIBP reading could not be obtained or an invasive pressure channel was not zeroed at the time of the trend entry, the data field will contain "xxx".

### 3.14.1 Modification of Parameters Displayed

The parameters displayed always include the currently active parameters and any others used since the time the patient was "admitted" to the monitoring system. The default order of parameters displayed from top to bottom is: HR, NIBP, SpO<sub>2</sub>, Resp, CO<sub>2</sub>, IBP1, IBP2, ST1, ST2, ST3, ST4, ST5, ST6, ST7, ST8, ST9, ST10, ST11, ST12, T1, O<sub>2</sub>, Agent, N<sub>2</sub>O, and PVC/min. To change the order of the parameters displayed, select "Setup" from the Graph trend menu. Once in the Setup Menu, change the Format selection from "Auto" to "Manual". The parameters to be displayed in each of the top 5 rows may then be specified.

### 3.14.2 Modification of Trend Entry Conditions

The Graph Trend data is the same as that stored for List Trends, arranged graphically. (If data is not available for time period, it appears as a gap in the Graph trend.) Refer to the previous section (List Trend) for modification of trend entry conditions.

### 3.14.3 Printing Graph Trend Data

To print, press the **PRINT TREND** key while the Graphic Trend is displayed. The recorder will print the displayed trends. Use the Vertical Scroll feature and the Zoom feature to display the parameters and time span desired to be printed. Press the **PRINT TREND** key again to stop printing at any time.

### 3.14.4 Transferring Graph Trend Data Between Different Passport 2 Monitors

Graph Trend data is transferred together with List Trend and patient name and demographics. Refer to the List Trend section for details.

### 3.14.5 Clearing Trend Data

To manually clear all trend data, including List and OXY CRG trends, choose "Clear Trends" from the menu. A confirmation prompt will appear. Once cleared, the data cannot be restored.

All trend data is automatically cleared when the patient is “discharged” from the monitor. All trend data is also cleared if the monitor’s displayed time or date is changed.

### 3.14.6 Removing the Graph Trend Display

The Graph Trend display does not automatically “time-out” and must be manually removed to return to the normal waveform display. To remove the Graph Trend display, choose “Normal Screen” from the menu, or press the **NORMAL SCREEN** key.

## 3.15 OXY CRG Display Menu (Passport 2 only)

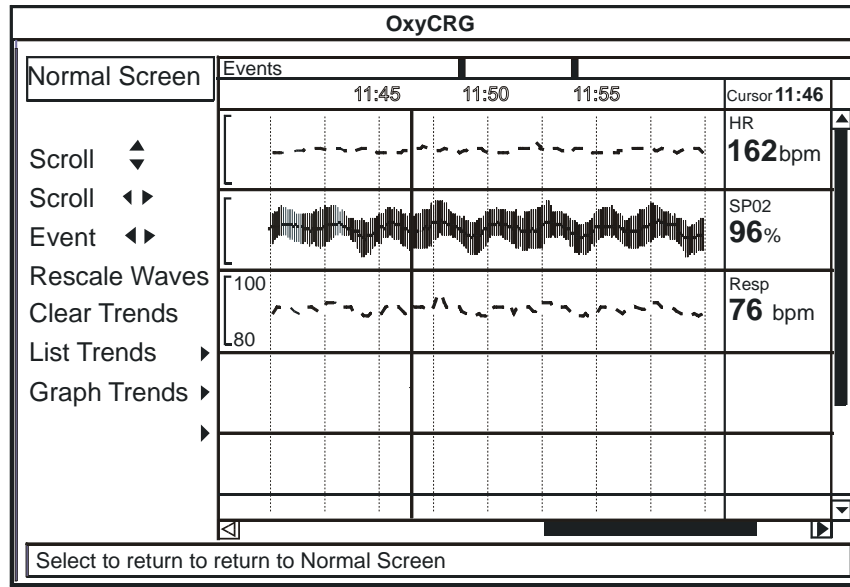

**FIGURE 3-22** OXY CRG Display Menu

The OXY CRG (Oxygen Cardiorespirogram) display allows the user to view a continuously updated graphic summary of 5 specific patient vital signs. This display is available for Neonate and Pediatric patient sizes only. To access this display from the normal monitoring screen, press the **TRENDS** key 3 times. To access this display from the List Trends display, press the **TRENDS** key twice. To access this display from the Graph Trends display, press the **TRENDS** key once. This display may also be accessed from the other trend displays via menu selection. A maximum of 6 minutes of data may be stored. If the "Extended Trend" option is installed, a maximum of 12 hours of data may be stored. When the maximum storage time has been reached, the oldest data will be deleted from the database in order to allow storage of new data.

The general operation and format of the OXY CRG menu items and display is the same as for Graph Trend display described previously.

### 3.15.1 Parameters Displayed

The parameters displayed are Heart Rate (from ECG source only), SpO<sub>2</sub>, Condensed thoracic impedance respiration wave (with digital rate data), IBP1, and Temperature.

### 3.15.2 Printing OXY CRG Data

To print, press the **PRINT TREND** key while the OXY CRG Trend is displayed. The recorder will print the 5 OXY CRG parameters. Press the **PRINT TREND** key again to stop printing at any time.

### 3.15.3 Transferring OXY CRG Data Between Different Passport 2 Monitors

OXY CRG data may not be transferred between monitors.



### 3.15.4 Clearing Trend Data

To manually clear all trend data, including List and Graph trends, choose "Clear Trends" from the menu. A confirmation prompt will appear. Once cleared, the data cannot be restored.

All trend data is automatically cleared when the patient is "discharged" from the monitor.

All trend data is also cleared if the monitor's displayed time or date is changed.

### 3.15.5 Removing the OXY CRG Display

The OXY CRG display does not automatically "time-out" and must be manually removed to return to the normal waveform display. To remove the Graph Trend display, choose "Normal Screen" from the menu, or press the **NORMAL SCREEN** key, or press the **TRENDS** key once.

## 3.16 Respiration Monitoring

The **Passport 2** Monitor offers two kinds of respiratory monitoring: Thoracic impedance and CO<sub>2</sub> (optional). Both methods offer certain benefits and limitations. A respiration source may be selected. The choices are Auto, CO<sub>2</sub> or ECG. When the Respiration source is set to AUTO, the unit will search for a source in the following order: CO<sub>2</sub> waveform from the optional Gas Module or from the optional Microstream<sup>®</sup> CO<sub>2</sub> (depending on settings in the Installation Menu), then ECG. The **Passport 2 LT** monitor offers Thoracic impedance respiratory monitoring. When the respiration source is ECG, either Lead I or Lead II may be selected. Lead II is the default.

**NOTE:** When 12 Lead ECG is enabled, Respirations can be acquired from the 3 Lead or 5 Lead ECG cables as well as CO<sub>2</sub>.

**CAUTION:** Some pacemakers may contain a respiratory sensor that may produce artifact on an ECG waveform.

### 3.16.1 Resp Menu

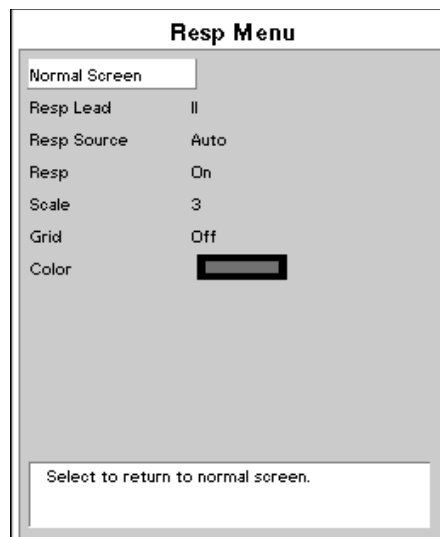

**FIGURE 3-23** Resp Menu

### 3.16.2 Thoracic Impedance

The **Passport 2/Passport 2 LT** Monitor presents a small electrical signal across the RA and LA (or RA & LL) ECG limb leads. This signal changes as the patient's chest wall rises and falls during the breath cycle. The advantage of the thoracic impedance method is that respiration is obtained non-invasively and without any extra cost. It is important to use cables with internal resistors for Thoracic Impedance, see Section 5.1.7 for a list of cables.

**CAUTION:** Thoracic impedance monitoring may affect rate responsive pacemakers.

Choke blocks are electrical filters that may be used in electro-cautery environments where ECG interference can be substantial. These filters remove the electro-cautery noise, but also block the signal used by the **Passport 2/Passport 2 LT** Monitor to measure respiration.

The filling and emptying of the heart chambers can interfere with the thoracic impedance signal, so called cardiovascular artifact (CVA), such that the respiratory signal matches the heart rate. The **Passport 2/Passport 2 LT** warns the operator when the respiration value equals the heart rate by displaying the CVA message.

If the patient's airway is obstructed and the patient attempts to breath, then the chest wall can move and create a respiratory signal even though no gas flow is occurring in the patient.

**CAUTION:** To avoid possible damage to the **Passport 2/Passport 2 LT**, use only ECG cables and accessories available from Mindray DS.

### 3.16.3 CO<sub>2</sub> Waveform (Passport 2 only)

When used with the optional Microstream<sup>®</sup> CO<sub>2</sub> or optional Gas Module the **Passport 2** may use the end tidal CO<sub>2</sub> waveform to report the respiration rate by measuring the actual breaths per unit time. The advantage of the CO<sub>2</sub> waveform method is that the signal is a direct result of respiration and can only occur if the patient is actually breathing. Refer to Section 3.16 for more details on the above options for CO<sub>2</sub> monitoring.

### 3.16.4 Respiration Monitoring on the Passport 2

The respiration wave appears by default in the third waveform area. An alternative location can be set by accessing the Display Setup Menu.

#### 3.16.4.1 Thoracic Impedance

Select lead to be used as Respiration Source on the Resp Menu. Lead II is the default setting. Thoracic impedance respirations can only be acquired from a 3 Lead or 5 Lead, non ESIS ECG cable.

#### 3.16.4.2 CO<sub>2</sub> Waveform (requires optional Microstream<sup>®</sup> CO<sub>2</sub> or Gas Module) (Passport 2 only)

If the RESP SOURCE is set to "AUTO", the source will switch to CO<sub>2</sub> source when a filterline is connected to the unit. If a filterline is not connected, the source will be ECG.

This source will switch to CO<sub>2</sub> if a Gas Module has been setup in the Installation Mode and is connected to the **Passport 2**. If the Gas Module has not been connected, the source will be ECG.

## 3.17 Microstream<sup>®</sup> CO<sub>2</sub> Monitoring (Optional Passport 2)

The **Passport 2** offers the MediCO<sub>2</sub><sup>®</sup> Microstream<sup>®</sup> CO<sub>2</sub> module. The Microstream CO<sub>2</sub> modules provides ETCO<sub>2</sub>, Inspired CO<sub>2</sub> and respiration rate monitoring utilizing a small lumen filterline. Microstream capnography can be acquired via a nasal cannula (non-intubated) or through a sampling line connected to a breathing circuit (intubated). Microstream can be used on adult, pediatric, and neonatal patients.

**WARNING:** When using Microstream<sup>®</sup> CO<sub>2</sub> Monitoring, the maximum sampling rate at the nasal cannula is 50 ml/min. This device should not be used on patients whose breathing could be impaired by this vacuum flow rate.

**WARNING:** Connection of the Passport 2's exhaust port to the hospital's waste gas scavenge system is recommended to prevent exposure of hospital personnel to the patient's respiratory sample.

### 3.17.1 Microstream CO<sub>2</sub>

1. Connect one end of an exhaust line to the exhaust port on the **Passport 2** and the other end to the hospital gas scavenging system.
2. Select CO<sub>2</sub> or AUTO as the Resp. Source in the Resp Menu.

**CAUTION:** Vacuum (negative pressure) should not exceed 1 mmHg at the Passport Pump Exhaust fitting. Excessive scavenge vacuum may result in an "OCCLUSION" message or damage to the Passport 2's internal pump. The scavenge system must be on during calibration.

3. Open spring loaded door and connect the proper filterline to the Monitor. Connect the opposite end to the patient.

**NOTE:** Ensure all tubing connections are secure. Ensure that the nasal cannula is away from all sources of CO<sub>2</sub> (including the patient's and your own exhaled breath and ventilator exhaust valves) during the warm up period.

4. When the **Passport 2** has detected valid breaths, numbers will display for ETCO<sub>2</sub>, Inspired CO<sub>2</sub> and Respiratory Rate.
5. The CO<sub>2</sub> respiration waveform and data will automatically replace the ECG Respiration waveform and data on the display. If respiration wave or data is not displayed, use the DISPLAY Setup Menu, to select RESP or CO<sub>2</sub> to be displayed on Waveform 2, 3 or 4.
6. If desired, the CO<sub>2</sub> waveform scale can be changed through the CO<sub>2</sub> menu.

**NOTE:** See Installation Mode Section 3.2, for CO<sub>2</sub> Units selection.

**NOTE:** See CO<sub>2</sub> Messages (only units equipped with CO<sub>2</sub>) Section 3.22.4 for more details on messages.

**WARNING:** Microstream<sup>®</sup> waste material and CO<sub>2</sub> filter should be treated as biohazard material.

### 3.17.2 Microstream® CO<sub>2</sub> Calibration

Accuracy verification of the Microstream CO<sub>2</sub> is recommended at 1 year intervals, or whenever the readings appear to be in error. The date of the last successful calibration appears on the CO<sub>2</sub> Calibration Menu.

Use Calibration Gas, P/N 0075-00-0033-01 and a Microstream FilterLine®, P/N 0683-0-0468-01.

**NOTE: For maximum accuracy, a 20 minute warm-up time is recommended.**

1. Connect the tubing that comes with the Calibration Gas to the gas canister and to the filterline. Attach the calibration gas / tubing assembly to the Microstream® port on the **Passport 2**.
2. Select the CO<sub>2</sub> parameter tile by rotating Navigator™ Control Knob clockwise and pressing the Knob after the CO<sub>2</sub> button is highlighted. (The same menu can be accessed by using the "PARAMETERS" tile and rotating to CO<sub>2</sub> and pressing the Knob.)

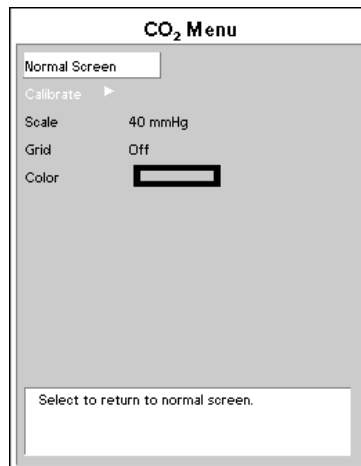

3. Select the **CALIBRATE** option and press the button on the gas canister to begin releasing the gas mixture.

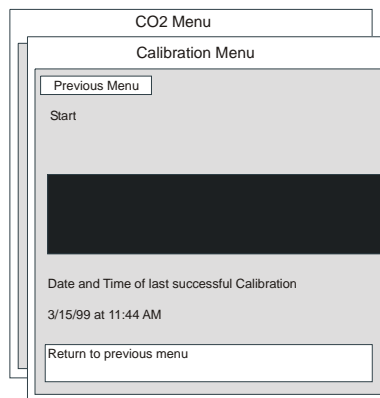

4. Select the **START** option in the Calibration Menu. Once the "START" option has been selected, no CO<sub>2</sub> waveform data will be displayed.

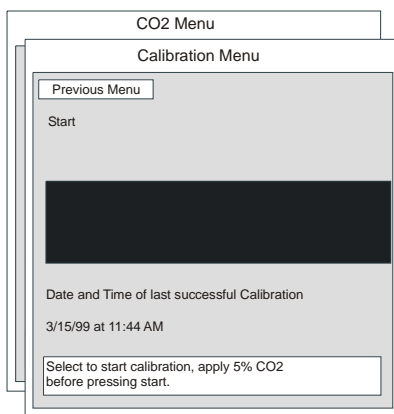

5. **CALIBRATING, CONTINUE TO APPLY 5% CO<sub>2</sub>** will appear in the message area of the Calibration Menu.

**NOTE:** If no gas is being delivered, or the mixture does not contain 5% CO<sub>2</sub>, the message "Calibration error. Caused by no gas or wrong gas concentration" will appear. Obtain a new gas canister and begin again with Step 1.

6. With the proper gas mixture being applied, the message "Calibrating, continue to apply 5% CO<sub>2</sub>" will remain in the menu. When the message changes to "Calculating, calibration gas can be removed". Release the button and remove the connector from the canister.

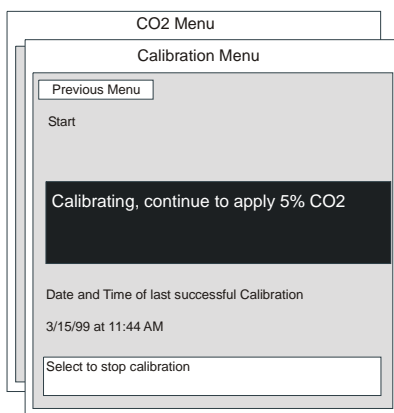

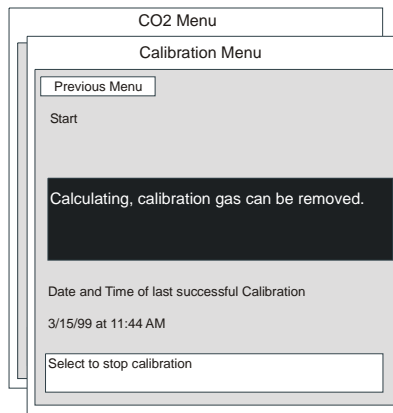

7. After a moment, the message will change to "Calibration Completed Successfully". The date and time of the successful calibration will appear in the body of the Calibration Menu.
8. Rotate the Navigator™ Control Knob to the selection for "Previous Menu" and press to select.

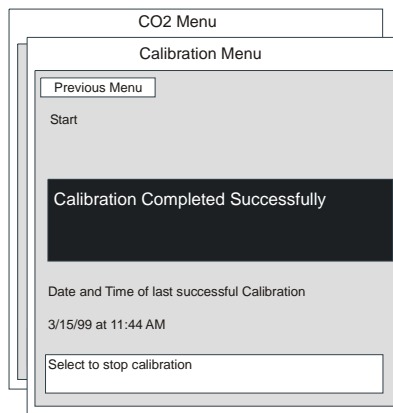

9. Rotate the Navigator Control Knob to select the "Normal Screen" and press to return to the monitors normal display screen.

## 3.18 Gas Module (optional Passport 2)

The Gas Module option allows for the measurement of anesthetic gases, O<sub>2</sub>, N<sub>2</sub>O and CO<sub>2</sub> levels. Measurement can be acquired via a nasal cannula (non-intubated) for oxygen and CO<sub>2</sub> only, or through a sampling line connected to a breathing circuit (intubated). For a complete listing of accessories, refer to Chapter 5.0.

**NOTE:** The Passport 2 will interface to the Gas Module via the SP1 Connector on the Comm-Port mounted onto the Passport 2.

**WARNING:** When using the Gas Module, the maximum sampling rate at the nasal cannula is 200 ml/min (120 ml/min for Gas Module 3 with a neonatal water trap). This device should not be used on patients whose breathing could be impaired by this vacuum flow rate.

**NOTE:** The Gas Module 3 is equipped with automatic barometric pressure compensation.

**NOTE:** The Gas Module 3 uses a fixed correction of 11 hPa to compensate for the influence of water vapor in the gas sample, when converting the gas readings to ATPD. An increase in the ambient H<sub>2</sub>O partial pressure to 30 hPa (i.e. 28 °C, 80% RH or 33 °C, and 60% RH) will cause a general error for all gases of only -2% REL.

### 3.18.1 Sequence for Monitoring Anesthetic Gases, O<sub>2</sub>, N<sub>2</sub>O and/or CO<sub>2</sub>

**NOTE:** To prevent moisture from entering the pneumatic system, ensure that the Gas Module is always installed and operated in the horizontal orientation shown in all graphical depictions.

1. Turn on the Gas Module and **Passport 2**, and configure the **Passport 2** Serial Port to be used with the Gas Module. Set alarms as necessary.

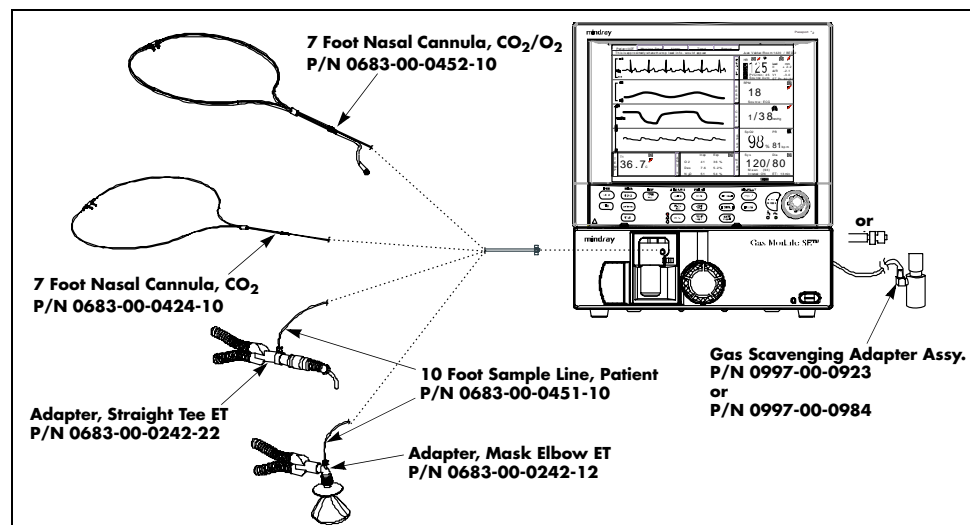

**FIGURE 3-24** Gas Module II and SE Airway Adapter



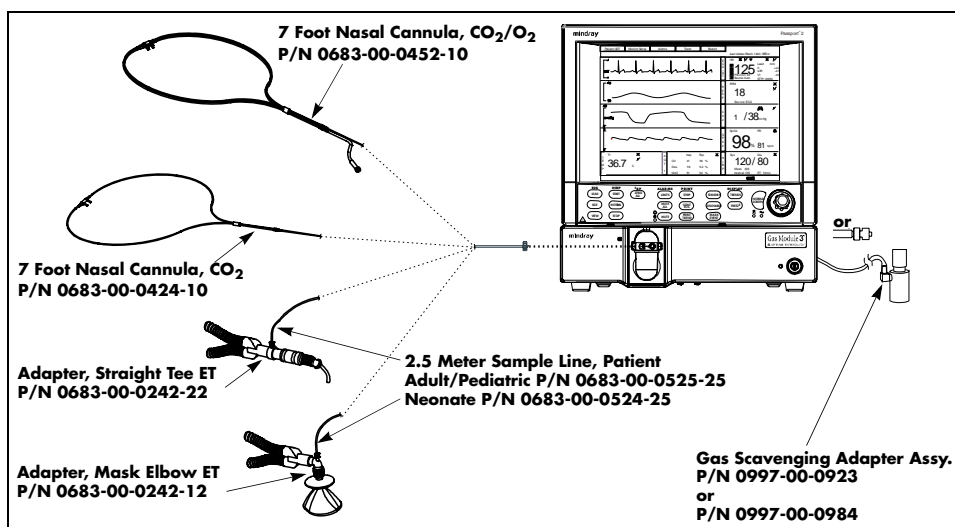

**FIGURE 3-25** Gas Module 3 Airway Adapter

**NOTE:** **DRYLINE™** Sample Lines are for Gas Module 3 only.

2. For non-intubated patients, apply the nasal cannula to the patient. For intubated patients connect the sample line to the breathing circuit. Refer to instruction provided in the packets.
3. Connect the other end of the nasal cannula or sample line to the Gas Module at the Input Port. Do not connect anything to Reference Port on the rear of the Gas Module II or SE. This port is used to monitor the room air only. Ensure all tubing connections are tight.

**WARNING:** Connection of the Gas Module exhaust port to the hospital's waste gas scavenge system is strongly recommended to prevent exposure of hospital personnel to the patient's respiratory sample. Vacuum (negative pressure) should not exceed 1 mmHg at the Gas Module Pump Exhaust fitting. Excessive scavenge vacuum may result in damage to the Gas Module's internal pump.

**CAUTION:** Contamination with CO<sub>2</sub>, N<sub>2</sub>O or Anesthetic Agent in the air surrounding the Gas Module 3 may cause significant measurement errors.

4. Check for a clean water trap. If cleaning is necessary, consult Section 4.9 for details.
5. Select Gas Module CO<sub>2</sub> or AUTO as the Resp. Source in the Resp Menu.
6. Observe the capnogram on the monitor's display. On **Passport 2/Passport 2 LT** powerup, O<sub>2</sub>, Agent and N<sub>2</sub>O numbers will display. CO<sub>2</sub> numbers will be displayed when a valid breath is detected.

**NOTE:** The Gas Module II and SE must be warmed up a minimum of two minutes for accurate CO<sub>2</sub>, O<sub>2</sub> and N<sub>2</sub>O readings and five minutes for agent readings.

**NOTE:** The Gas Module 3 must be warmed up a minimum of 45 seconds for ISO accurate CO<sub>2</sub>, O<sub>2</sub>, N<sub>2</sub>O, and agent readings.

7. If not already set, use the Monitor Setup Menu to select the gas waveforms to be displayed in Waveform area 2, 3 or 4.
8. If desired, the Gas waveform scale and speed can be changed by entering the Gases menu. See Section 2.3 for Menusdetails.

**NOTE:** See **Passport 2 / Gas Module Messages (only observed when Gas Module is installed) in Section 3.22.5 for more details on messages.**

### 3.18.2 Gas Module 3 Pre-use Test

Prior to each use, perform the following test with the Gas Module 3 to verify that the gas analyzer and sample system are functioning properly:

1. Verify that the appropriate water trap is properly installed and that the appropriate sampling line is connected.
  - DRYLINE™ Adult/Pediatric water trap used with DRYLINE™ Adult/Pediatric sampling line (colorless Luer lock nut)
  - DRYLINE™ Neonatal water trap used with DRYLINE™ Neonatal sampling line (blue Luer lock nut)
2. Verify that the water trap container is less than half full.
3. Occlude the sampling line and verify that the occlusion alarm functions properly.
4. Breathe into the sampling line and verify that a CO<sub>2</sub> waveform is correctly displayed on the monitor.
5. Sample room air for 30 seconds and verify that the monitor oxygen output is 20.95% ( $\pm$  sensor inaccuracy).

### 3.18.3 Gas Monitor Calibration

Accuracy verification of the Gas Module II and SE is recommended at six (6) month intervals or whenever gas readings appear to be in error. Accuracy verification of the Gas Module 3 is recommended at one (1) year intervals or whenever gas readings appear to be in error. The date of the last successful mixture calibration appears at the bottom of the "Gas Calibration" menu. During the calibration session gas readings and all other gas functions are not available. Span calibration is a set of prompted commands that enables the operator to align the gas display(s) to specific gas concentration(s) within the Mindray DS Calibration Gas canister. Span calibration can be initiated by the operator any time the gas module's readings are suspected to be inaccurate.

Always verify accuracy using a full canister of Mindray DS approved precision calibration gas, after calibration is performed (See Chapter 5.0, Accessories for the Mindray DS Part Number). Never use calibration gas that has expired, has a different concentration, or a canister that is indicating low pressure. The pressure indicator on the Mindray DS gas regulator must operate in the green zone during the entire calibration session.

**NOTE: The Gas Module II and SE must be fully warmed up before performing a gas calibration. For maximum accuracy, a warm-up time of 30 minutes is recommended.**

**NOTE: The Gas Module 3 must be fully warmed up before performing a gas calibration. For maximum accuracy, a warm-up time of 10 minutes is recommended.**

1. Select **Calibrate** from the **Gas Menu**. The menu shown will appear

The screenshot shows a "Gas Menu" interface with the following settings:

Gas Menu	
Normal Screen	
Select Agent	Auto
Calibrate	
Grid	Off
O2 Scale	100 %
O2 Color	<input type="checkbox"/>
N2O Scale	100 %
N2O Color	<input type="checkbox"/>
Agent Scale	100 %
Agent Color	<input type="checkbox"/>
Select to return to normal screen.	

2. Select the calibration gas type from the choices, and **START** to begin calibration.

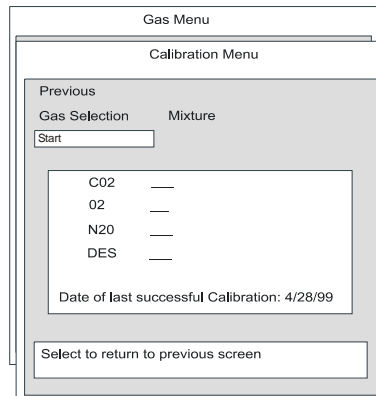

3. At the start of the calibration, the Gas Module will zero the gas channels. After a successful zeroing, the Gas Module will request the calibration gas.

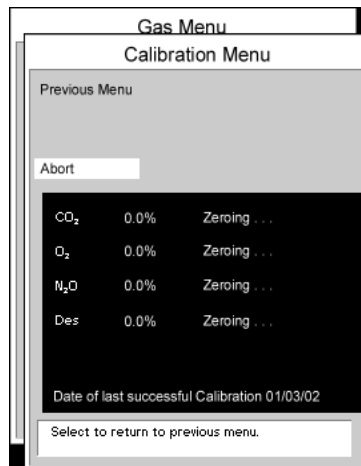

**NOTE:** If the Gas Module cannot zero, a “zeroing error” will be displayed and the previous calibration data will be restored. Repeat the calibration procedure from step 1. If problems persist, call for service.

4. The message "Feed Calibration Gas" will appear. At this point, attach the calibration gas canister to the regulator and turn it on. Increasing gas values will appear in the window as the Gas Module samples the calibration gas.

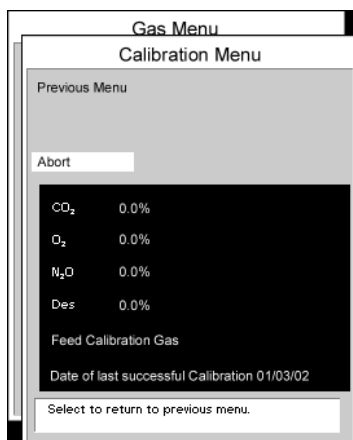

5. When sampling is complete, the "Feed Calibration Gas" message will disappear, "Adjusting" will appear next to each value and an "Accept" menu item will appear. If the values are acceptable, select "Accept". If for any reason, it is desired to cancel calibration, press Abort to re-install the previous calibration values.

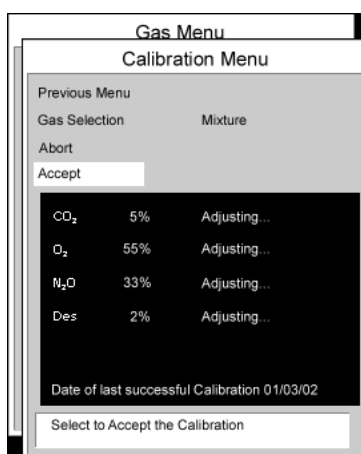

- NOTE:** To avoid premature emptying of the gas canister, always remove the regulator at the end of the procedure.
- NOTE:** For Gas Module II and SE, if any channel cannot be calibrated due to a sampling error, the "Sampling Error" message will appear. Selecting the "Accept" button will calibrate only those channels that do not have a sampling error. If any channel fails calibration, the gas value will be "XXX". These channels will appear as "XXX" in the normal run mode as well. Repeat procedure from step 1. If problems persist, contact Mindray DS Customer Support.
- NOTE:** For Gas Module 3, if any input data is corrupt or if there are other errors, a "Calibration Error" message will appear after the "Accept" button is selected. The Gas Module 3 will not accept span calibration with errors in any channel.

## 3.19 Alarms

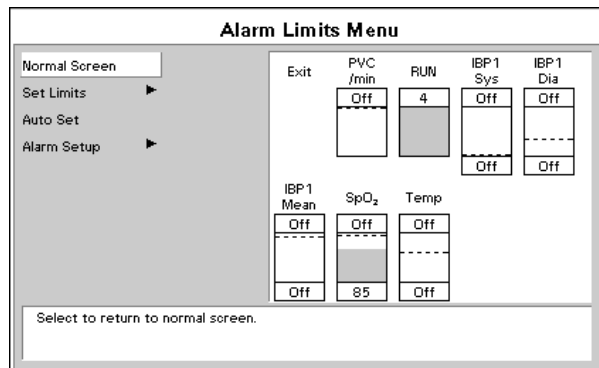
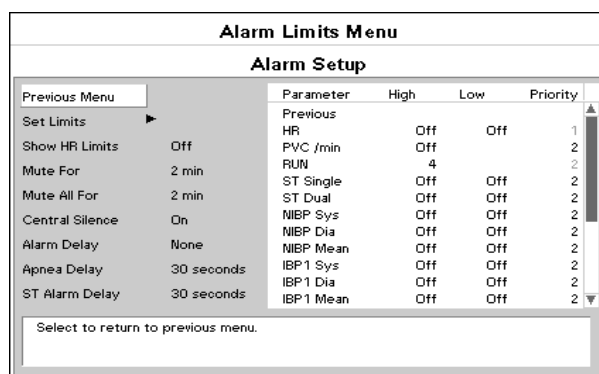

**FIGURE 3-26** Alarms

The **Passport 2/Passport 2 LT** provide high and low alarm limits for heart rate (HR), Systolic, Diastolic, and Mean Pressure (NIBP), respiration rate, SpO<sub>2</sub> and temperature. The **Passport 2** monitor also provides alarms for ST level, ventricular arrhythmia, low and high alarm limits for Systolic, Diastolic and Mean Pressure (IBP1 and IBP2), inspired/expired CO<sub>2</sub>, O<sub>2</sub> and N<sub>2</sub>O. Alarms for apnea delay time are available within the **Passport 2/Passport 2 LT**.

### 3.19.1 Setting Parameter Alarm Limits

1. To access the Alarms Limits menu press the **ALARMS LIMITS** key. The main Alarm Settings menu displays.
2. Using the Navigator™ Control Knob (as described in 2.3, Menus) set parameter limits as desired.



**FIGURE 3-27** Alarms

**NOTE:** Alarms can be set for any active parameter through the main Alarm limits menu. To set other parameter's alarms, enter the Alarms Setup option. Alarm limits can be set separately for each patient size from the Alarm Limits Menu. Alarm limits are not saved when the monitor is turned off, unless you select "Save Current" in the Monitor Setup menu.

**NOTE:** Alarm limits can be set using the “Auto-Set” function. Alarm limits can be saved in the Monitor Setup Menu. The “Save Current” option must be selected in order to save the current parameters.

### 3.19.2

## Alarm Limits

All of the alarm limits have an “OFF” position with the exception of low SpO<sub>2</sub>, high inspired N<sub>2</sub>O and low inspired O<sub>2</sub>. A separate table of alarm limit settings is maintained for each patient size. When the patient size is changed, the appropriate selections are automatically used. See table below for alarm ranges.

## Alarm Parameters

PARAMETERS	HIGH			LO		
	ADULT	PED	NEONATE	ADULT	PED	NEONATE
Heart Rate (bpm)	Off, 60-250	Off, 100-300	Off, 100-350	Off, 30-120	Off, 30-150	Off, 30-200
PVC/ min	Off, 1-30					
Run**	4 / 4-8					
ST Single Lead (mm)	Off, +0.5 - +10.0 (Elevation)			Off, -0.5 - -10.0 (Depression)		
ST Dual Lead (mm)	Off, +0.5 - +10.0 (Elevation)			Off, -0.5 - -10.0 (Depression)		
NIBP Sys (mmHg)	Off, 70-240	Off, 40-180	Off, 40-180	Off, 50-150	Off, 15-130	Off, 15-130
NIBP Mean (mmHg)	Off, 60-200	Off, 50-180	Off, 40-160	Off, 40-140	Off, 10-100	Off, 10-70
NIBP Dia (mmHg)	Off, 40-130	Off, 50-100	Off, 50-100	Off, 30-120	Off, 10-50	Off, 10-50
IBP1/IBP2 Sys (mmHg)	Off, 5-300	Off, 5-240	Off, 5-180	Off, 0-150	Off, 0-130	Off, 0-130
IBP1/IBP2 Mean (mmHg)	Off, 5 - 150	Off, 5 -100	Off, 5 - 100	Off, 2-100	Off, 2 - 50	Off, 2-50
IBP1/IBP2 Dia (mmHg)	Off, 0-140	Off, 0-100	Off, 0-70	Off, 0-120	Off, 0-100	Off, 0-50
SpO <sub>2</sub> (%)	Off, 80-100	Off, 80-100	Off, 80-100	50-99	50-99	50-99
T1 (°F)	Off, 95-110			Off, 80-100		
T1 (°C)	Off, 35-43			Off, 26-38		
Resp Rate (rpm)	Off, 10-100	Off, 15-150	Off, 30-200	Off, 5-30	Off, 5-40	Off, 5-50
ET CO <sub>2</sub> (mmHg)	Off, 20-80			Off, 5-50		
ET CO <sub>2</sub> (%)	Off, 2.0-10.0			Off, 1.0-6.0		
ET CO <sub>2</sub> (kPa)	Off, 2.0-10.0			Off, 1.0-6.0		
Insp CO <sub>2</sub> (mmHg)	Off, 5-30					

\*\* Passport 2 only with 3-lead or 5-lead.

## Alarm Parameters (Continued)

PARAMETERS	HIGH			LO		
	ADULT	PED	NEONATE	ADULT	PED	NEONATE
Insp CO <sub>2</sub> (%)	Off, 1.0 - 4.0					
Insp CO <sub>2</sub> (kPa)	Off, 1.0 - 4.0					
ET O <sub>2</sub>	Off, 40-100	Off, 40-100	Off, 40-100	Off, 10-60	Off, 10-60	Off, 10-60
Insp O <sub>2</sub>	Off, 40-100	Off, 40-100	Off, 40-100	18-60	18-60	18-60
ET N <sub>2</sub> O	Off, 10-80	Off, 10-80	Off, 10-80	Off, 5-70	Off, 5-70	Off, 5-70
Insp N <sub>2</sub> O	10-80	10-80	10-80	Off, 5-70	Off, 5-70	Off, 5-70
Apnea Delay (seconds)	10-60	10-20	10-20			

\*\* *Passport 2 only with 3-lead or 5-lead.*

## Alarm Parameters (Gas Module Only)

PARAMETERS	HIGH SETTINGS	LOW SETTINGS	DEFAULT
Insp. Hal	Off, 2-10	Off, 0.5-5	Off
ET Hal	Off, 2-10	Off, 0.5-5	Off
Insp. Iso	Off, 2-10	Off, 0.5-5	Off
ET Iso	Off, 2-10	Off, 0.5-5	Off
Insp. Enfl	Off, 2-10	Off, 0.5-5	Off
ET Enfl	Off, 2-10	Off, 0.5-5	Off
Insp. Sevo	Off, 2-10	Off, 0.5-5	Off
ET Sevo	Off, 2-10	Off, 0.5-5	Off
Insp. Des	Off, 2-20	Off, 0.5-10	Off
ET Des	Off, 2-20	Off, 0.5-10	Off

All Gas Module alarms are in units of % and increment in units of 0.5.

## 3.19.3 Auto-Set Alarms

To automatically set alarms, choose "Auto Set" in the Alarms Menu. Auto Set will cause auto alarm limit functions to be set for active parameters at the time of activation as follows:

- +/- 20% of absolute value for: CO<sub>2</sub>, Gases, IBP's and NIBP
- HR and Resp. Rate: +/- 30%
- Temp: +/- 3.0%.

Press **YES** to confirm the Auto-Set in the Confirmation window when it appears.



### 3.19.4 Alarm Violations

Alarms are classified by severity: Warnings (Priority 1) and Cautions (Priority 2).

Warnings are HIGH priority and activate a red LED. Cautions are lower priority and activate a yellow LED on the keypad.

#### A. Parameter Alarms

An alarm condition exists if the parameter is equal to or is outside the high/low limit range. When an alarm limit is violated, the following actions occur:

- The red or yellow alarm LED flashes, according to the priority of the alarm.
- An alarm tone is sounded (unless it is muted with the **MUTE ALL** key), according to the priority of the alarm.
- The recorder prints the currently selected waveform (if Record On Alarm is selected from the Recorder menu).

**NOTE:** **On the waveform printouts that are caused by alarm situations, a bar is printed above the alarming area. On trend printouts, the value that has caused an alarm is printed with square brackets around it. If the recorder is printing a waveform and an alarm situation occurs, the currently printing waveform will be aborted and the new alarm waveform printout will be printed.**

The data for the violated parameter is displayed in reverse graphics in the parameter window.

The display indicates the priority of the alarm as follows:

#### On color displays:

- Priority 1 alarm data is shown in inverse video with red background.
- Priority 2 alarm data is shown in inverse video with yellow background.

#### On monochrome displays:

- Priority 1 alarm data is shown in inverse video with background at full brightness.
- Priority 2 alarm data is shown in inverse video with background at half brightness.

If a parameter is being monitored but data is not being displayed, an alarm message will be posted at the top of the display.

#### B. Heart Rate Fault Alarm

The Heart Rate Fault Alarm occurs if the selected heart rate source is no longer able to detect a heart rate. This may be due to an ECG lead fault, a problem with an SpO<sub>2</sub> sensor, or various other reasons. This alarm is only active if a low heart rate limit is set. The alarm operation is the same as for a parameter alarm. A further message from a lead fault or SpO<sub>2</sub> fault may be present to help diagnose the problem. The heart rate alarm is a Priority 1 alarm.

**NOTE:** **Only the value displayed in the heart rate window is used to determine heart rate alarm conditions.**

### C. Apnea Alarm

The Apnea Alarm is active when respiration is being monitored. The Apnea alarm is violated when breathing is not detected for a longer period of time than the apnea delay specified in the Alarms Menu. When the alarm is silenced by pressing **MUTE** or **MUTE ALL**, the alarm tone will cease to be heard. The mute period, as set in the Alarms Menu, will now begin to count down. If normal breathing occurs during the selected time frame for "MUTE", the **Alarms Muted for...** message will disappear. Apnea is a Priority 1 alarm.

### D. Arrhythmia Alarms (**Passport 2** only)

Arrhythmia alarms are defined in section 3.10.

Non-lethal arrhythmia conditions are defined as:

- Bradycardia, Irregular Heart Rate (3/5-Lead ECG only)
- Pause (View 12™ ECG Module only)
- Ventricular Rhythm (V-Rhythm), Couplet, Bigeminy, Trigeminy, PVC's per minute, and Run.

Once an alarm condition has been triggered for any of these non-lethal arrhythmias, it can be silenced by pressing **MUTE** or **MUTE ALL**. During the muted period, as established in the Alarms Menu, if a second non-lethal arrhythmia condition occurs, it will be identified in the message area of the **Passport 2** but will not sound an alarm until the preset, mute period of time has elapsed. Non-lethal arrhythmia conditions are Priority 2 alarms.

Lethal arrhythmia conditions are defined as Asystole, Ventricular Tachycardia, and Ventricular Fibrillation. Once V-Tach, V-Fib, or Asystole occurs, the alarm is latched. Even after the alarming condition is resolved, a latched alarm will continue until it is acknowledged by pressing the **MUTE** or **MUTE ALL** key on the front panel keypad. If the alarm is acknowledged while the lethal condition still exists, the audio portion of the alarm will be muted for the duration that is selected from the "Mute For" list in the "Alarm Setup" menu, but the alarm message will remain in message area A. If a new lethal condition occurs while the initial lethal alarm is muted, the new lethal alarm will not break through and will be muted for the remainder of the mute duration. If the lethal condition is resolved while the alarm is muted, the alarm will be terminated.

### E. General Alarms

**ALARMS OFF ICON**  - If both high and low alarms are not set for a parameter, an alarm off icon, resembling a crossed bell, will be displayed next to the numerical data for that parameter.

**VOLUME KEY** - The loudness of the alarm can be adjusted through the Monitor Setup Menu.

**ALARM MUTES** - One or more alarms can be muted for a programmable length of time. The following is a description of how to enable the different mute modes.

**MUTE**  - This key is a single action button, which when pressed, silences the alarm whose parameters have been violated for a programmed length of time (Default 2 minutes), or until the alarm condition is no longer present, whichever is shorter. Any new alarms that occur during the silenced period will disable the silence and the alarm will sound the tone. An Alarm Mute icon, resembling a crossed speaker, is displayed next to each muted parameter. A message and digital timer counts down in the upper message area. Pressing **MUTE** again does not re-enable audio alarms

**MUTE ALL**  - This is a single action button, which when pressed, suspends alarms on all parameters for a programmed period of time. (Default is 2 minutes). An Alarm Mute icon (resembling a crossed speaker) is displayed next to each parameter. A message and timer appear in the upper message area showing the time remaining. Pressing **MUTE ALL** at any time re-enables audio alarm tones. If **MUTE ALL** was permanently selected a message is posted stating **All alarms muted permanently**.

The time period for **MUTE** and **MUTE ALL** is adjustable via the ALARMS SETUP Menu.

### 3.19.5 Beep Tones

The following chart describes the beep tones of the **Passport 2** monitor:

**TABLE 3-1**

<b>POWER ON</b>	
Normal Operation	1 beep
Runtime Stack Failure	2 beeps
DRAM Memory Failure	3 beeps
PCMCIA Boot Checksum Failure	4 beeps
PCMCIA Image Checksum Failure	5 beeps
Flash Checksum Failure	6 beeps
Flash Programming Error	7 beeps
DRAM Checksum Error	8 beeps
<b>ALARMS</b>	
High Priority	3 beeps followed by 2 beeps, repeated every 5 seconds
Low Priority	3 beeps, repeated every 30 seconds
<b>NORMAL OPERATION</b>	
CO <sub>2</sub> Occlusion	2 beeps repeated every 4 seconds
NIBP Unable to Measure	1 beep
Low Battery	2 beeps every minute

## 3.20 Recorder (Optional)

The **Passport 2/Passport 2 LT** Recorder can provide a printed record of all of a patient's monitored parameters. It is a two trace thermal strip chart recorder with an integral paper spool and uses plain white thermal paper, 5 cm wide. (see Section 4.7 for replacement instructions).

**NOTE:** All grid patterns and data are printed by the recorder.

### 3.20.1 Print Setup Menu

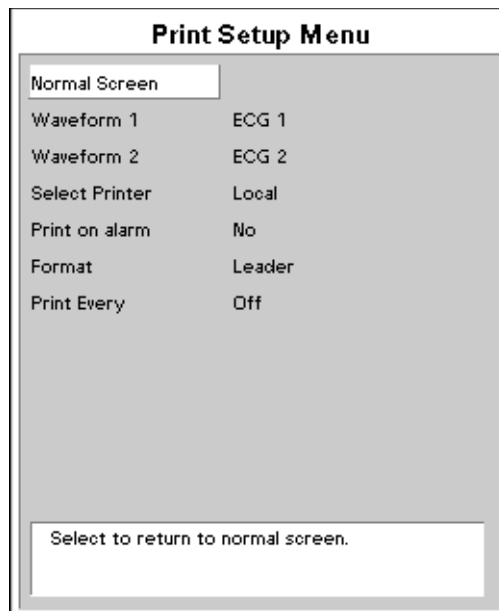

**FIGURE 3-28** Print Setup Menu

### 3.20.2 Operation of Recorder

1. Select the waveforms to print on the recorder via the Print Setup menu using the Navigator™ Control Knob.
2. Select the printer destination (local), in the Print Setup menu. The default destination is LOCAL; the print will be produced by the local printer
3. Press the **STRIP** key to initiate a printing or stop a printing when one is in progress.

When **STRIP** is pressed to initiate a printing, a 16 second strip is printed. The 16 second strip consists of waveforms 8 seconds prior to and 8 seconds after the time **STRIP** is pressed. If a continuous printing of ECG1 and ECG2 is required, press the **CONT ECG** key. (Cont ECG produces a real-time strip: It does not include 8 seconds of data accumulated prior to the key press.) Press **CONT ECG** again to stop printing.

**NOTE:** When the waveforms are frozen and STRIP is pressed, the recorder prints 8 seconds of the frozen displayed waveforms.

The data and waveforms printed at a remote printer are determined by the setup of that device.

Press the PRINT TREND key while the List Trend is displayed, to print a list trend report. See Section 4.7 for Recorder Paper Replacement.

### 3.20.3 Printer Formats

#### Single waveform format

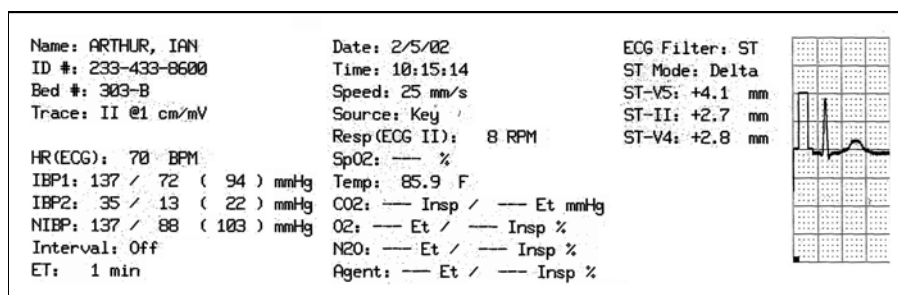

**FIGURE 3-29** Sample Printout, Single Waveform

The waveform for rule-scaled waveforms (i.e. ECG) will be an exact rendering. However, non-rule scaled waveforms will be transformed to fit the full excursion of the 40mm waveform window at the selected scale. The baseline of printed waveforms will follow that of the displayed waveform

#### Two waveforms separate field format

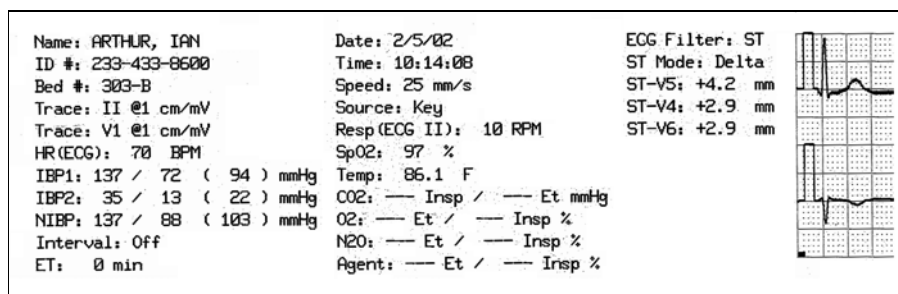

**FIGURE 3-30** Sample Printout, Two Waveform

The two waveforms are printed in a separate field format with two centimeters assigned to each waveform. The waveforms do not overlap. Grids are printed as for one waveform.

The upper and lower borders are printed as for the single waveform.

## Trend list Format

	Time:	HR BPM	SpO2 %	Resp RPM	IBP1 mmHg	IBP2 mmHg
Name: _____						
ID #: _____						
Bed #: _____	0:40	60	95	9	109 / 60 ( 69 )	119 / 70
Date: 1/3/70	0:40	60	95	9	109 / 60 ( 69 )	119 / 70
Time: 12:40:03 AM	0:39	60	95	9	109 / 60 ( 69 )	119 / 70
	0:39	60	95	8	109 / 60 ( 69 )	119 / 70
	0:38	60	95	11	109 / 60 ( 69 )	119 / 70
	0:38	60	95	11	109 / 60 ( 69 )	119 / 70
	0:38	60	95	11	109 / 60 ( 69 )	119 / 70
	0:38	60	95	14	109 / 60 ( 69 )	119 / 70

**FIGURE 3-31** Sample Printout, Trend List Format

The list trend data is printed with text running along the length of the strip. If more than one page of data is available then all additional pages are printed along the length of the strip.

**NOTE:** On waveform printouts that are caused by alarm situations (Record on Alarm must be selected YES in the Print Set-Up menu), a bar is printed above the alarming area. On trend printouts and in annotations, the value that has caused an alarm is printed with square brackets around it. If the recorder is printing a waveform and an alarm situation occurs, the currently printing waveform will be aborted and then the alarm waveform printout will be printed.

**NOTE:** IBP1, IBP2, CO<sub>2</sub>, and Gas Module data is printed only when models are equipped with these options.

**NOTE:** The print format can be changed via the PRINT SET UP Menu. Digital parameter data can be placed either in the leader or the top and bottom of the waveform.

## Graph Trend Format: (Passport 2 only)

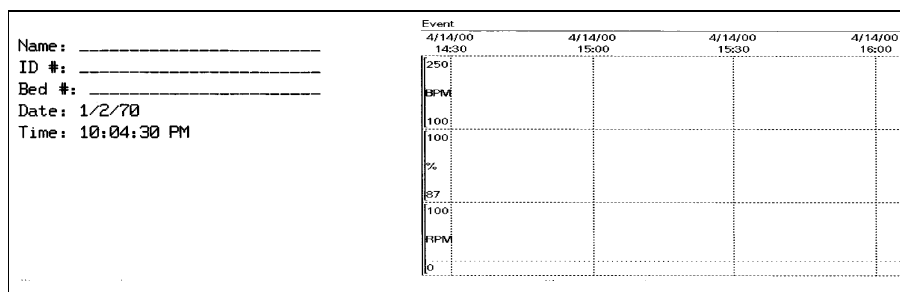

**FIGURE 3-32** Graph Trend Format

### OXY CRG Format: (Passport 2 only)

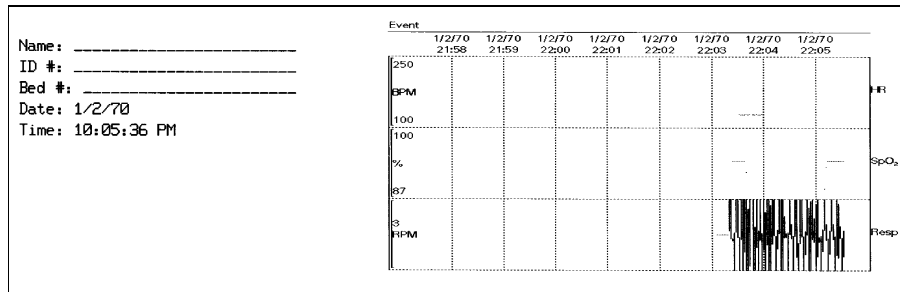

**FIGURE 3-33** OXY CRG Format

### 12 Lead Format: (Passport 2 only)

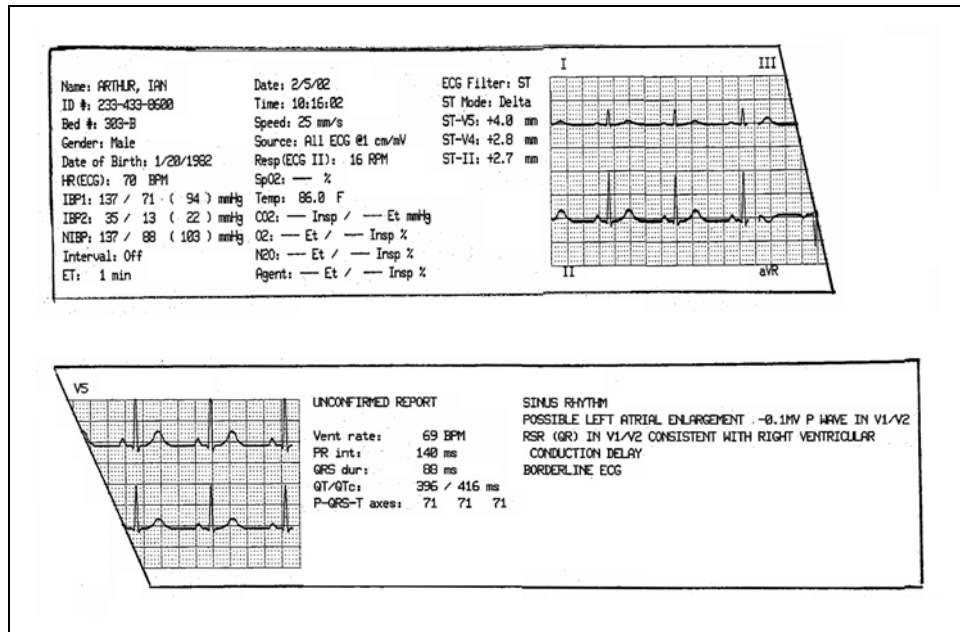

**FIGURE 3-34** 12 Lead Format

To print 12 Lead ECG data and analysis on the internal thermal recorder, press the **VIEW** key, then press **STRIP**. The recorder will print the patient’s demographic data vital sign data (as for a normal waveform printout) followed by a 2 ½ second sample of each of the 12 ECG vector waveforms. The waveform samples represent the 2 ½ seconds prior to pressing **STRIP**. These waveforms will be followed by ECG measurement data (Ventricular rate, PR interval, QRS duration, QT/QTc and P-QRS-T axes). If all conditions have been met for ECG analysis, the recorder will add this following the ECG measurement data. The analysis will consist of an interpretive statement, a condition statement, and a rhythm statement as specified in the Physician’s Guide to Computerized ECG Analysis (Mindray DS P/N’s 0070-00-0524-01 English, 0070-00-0524-50 all other languages).



The conditions for printing the ECG analysis are:

1. The **Passport 2** patient size must be set to **Adult**.
2. The patient's gender and date of birth must be entered via the Patient menu.
3. The patient must be at least 18 years old. (The monitor calculates the patient age from the date of birth entered.)

### Average ST Complex Format: (Passport 2 Only)

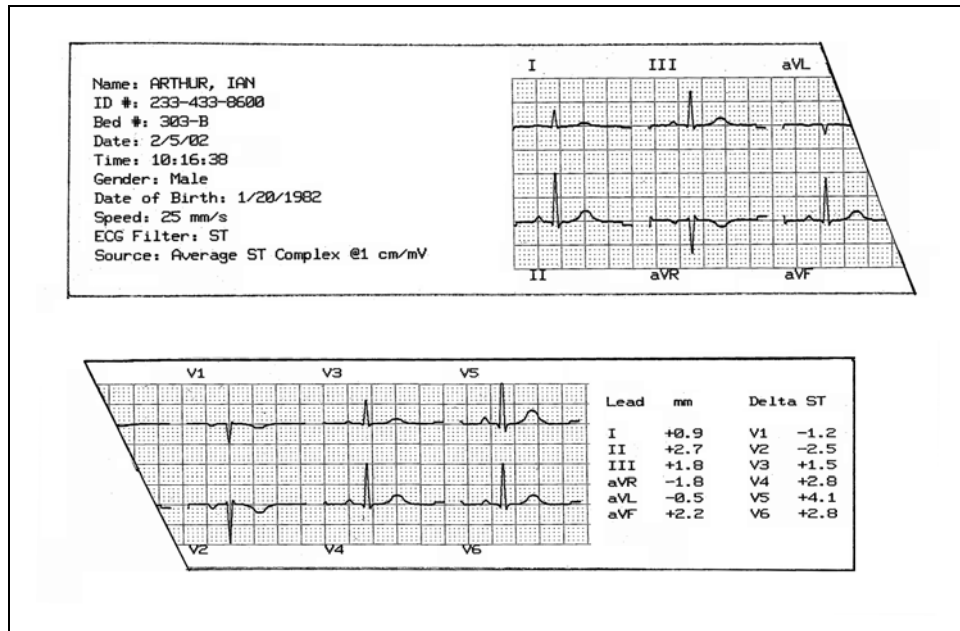

**FIGURE 3-35** Average ST Complex Format

To print the Average ST Complex, use the Navigator Control knob to select the **Print Setup** menu, then scroll and select **Average ST Complex**.

**NOTE:** This menu selection is only available when ST analysis has been enabled and the "learning" cycle completed.

The recorder will print the patient's demographic data, followed by the average ST complex for each of the 12 ECG vectors, then followed by the current ST data for each of the 12 ECG vectors.

## 3.21 Laser Printing 12 Lead ECG (optional - Passport 2 only)

The Passport 2 may be connected to a laser printer to print 12 Lead ECG data and interpretation. Please refer to P/N 0070-00-0441-02 for Laser Printer setup instructions and refer to section 5.1.9 for the approved printer(s).

### 3.21.1 Printing 12 Lead to the Laser printer

1. To select the destination for your 12 Lead ECG data, go to the Print Setup menu and ensure "Select Printer" is set to Laser, Laser/Local or Laser/Remote.
2. To print 12 Lead ECG data to the laser printer, the View 12 Lead ECG Analysis Module must be installed and enabled within the Passport 2.
3. Enter patient's Date of Birth and Gender into the Patient menu to print the 12 Lead interpretation.
4. Press the **VIEW** key to display View All ECG mode.
5. Press the **STRIP** key to print 12 Lead ECG to the destination of choice.

The laser printer will print the patient's demographic data, vital sign data (as for a normal waveform), and ECG measurement data (Ventricular rate, PR interval, QRS duration, QT/QTC and P-QRS-T axes) in the upper left portion of the printout. If all conditions are met for ECG analysis, the 12 Lead interpretation will be printed in the upper right portion of the printout. Analysis consists of an interpretive statement, a condition statement and a rhythm statement as specified in the Physician's Guide to Computerized ECG Analysis (Mindray DS P/N 0070-00-0524-01).

Below the digital information and interpretation are 2-½ second samples of each of the 12 ECG vector waveforms displayed in standard 12-Lead format. The waveform samples represent the 2-½ seconds prior to pressing the **STRIP** key. Beneath the 12 ECG waveform samples is a 10-second rhythm strip of ECG Lead II.

The conditions for printing the ECG analysis are:

1. The Passport 2 patient size must be set to "Adult."
2. The patient's Gender and Date of Birth must be entered via the Patient menu.
3. The patient must be at least 18 years old. (The monitor calculates the patient's age from the Date of Birth entered).

### 3.21.2 Laser Printing 12 Lead Format: (Passport 2 only)

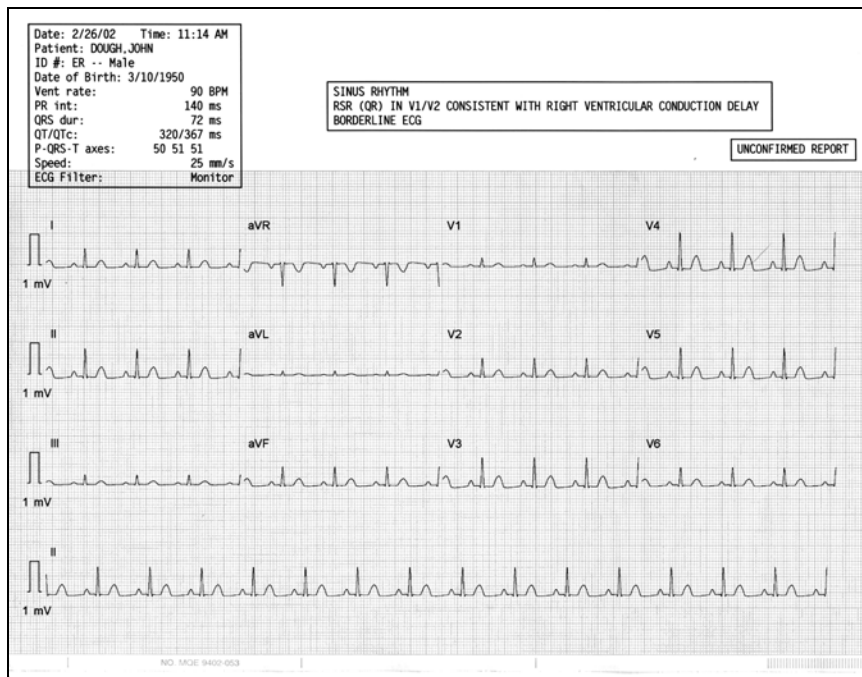

## 3.22 Status Messages

The monitor uses the Message Display Area to provide messages to the user relating to monitor status. The following is a list these messages and a description of the message. The messages are grouped by function.

### 3.22.1 NIBP Measurement Messages

MESSAGE	REASON	ACTION
NIBP: Idle	Displayed while system is idle. Note: This is not displayed while in the interval mode.	Press <b>START</b> to take a single measurement. Select an interval and start timed measurements.
NIBP: Deflate	Displayed when a measurement that is in process is stopped by pressing the <b>STOP</b> key.	Press <b>START</b> to take an immediate measurement and resume timed measurements.
NIBP: Interval	Displayed during the interval between two timed measurements.	Press <b>STOP</b> to suspend timed measurements. Change timer to OFF to stop timer.
NIBP: Failure	The system has detected an unrecoverable failure of the NIBP system.	Power cycle unit. If message reappears, call Service.
NIBP: Measuring	Displayed during a measurement. Cuff pressure is also displayed.	Press <b>STOP</b> to suspend a measurement and deflate the cuff.
NIBP: Retry Pump Higher	A measurement has been attempted but no reading was possible. This results from inadequate cuff inflation.	Retry will be attempted. Check that appropriate patient size is set. Preset initial inflation pressure.
NIBP: Retry	A measurement has been attempted but no reading was possible and the retry limit has not been reached.	Retry will be attempted. Check for leaks and quality of peripheral pulses. Decrease patient movement. Switch cuff to another limb.
NIBP: Unable To Measure*	An unsuccessful measurement cycle has been completed.	Switch cuff to another limb. Decrease patient movement. Press <b>START</b> to retry. Be prepared to auscultate BP manually.
NIBP: Cuff Overpressure	The hardware overpressure limit has been exceeded.	Power cycle unit. If message reappears, call Mindray DS Service.
NIBP: Cuff Overpressure/Press STOP to clear.	The hardware overpressure limit has been exceeded.	Press <b>STOP</b> to clear the hardware overpressure. If message reappears, call Mindray DS Service.
NIBP: Check Calibration	The software has detected that the overpressure transducer is out of calibration.	Have the unit calibrated. If problem persists call Mindray DS service.

\* *The presence of arrhythmias may increase the time required to complete a measurement and may extend this time to a point where a measurement cannot be completed.*

- Always have an alternate method of BP verification available.
- On vasoconstricted patients, failure to evacuate air from the cuff can distort BP measurement.
- Do not place cuff on extremity that has an IV.
- Cuff should be at heart level.

### 3.22.2 SpO<sub>2</sub> Messages

The following messages pertain to SpO<sub>2</sub> Operation.

MESSAGE	REASON	ACTION
SpO <sub>2</sub> : No Sensor	Sensor is not plugged in to the <b>Passport 2</b> .	Plug the sensor into the monitor
SpO <sub>2</sub> : Sensor Off (Masimo Only)	Sensor may not be connected to the patient.	Check patient connection.
SpO <sub>2</sub> : Interference	Noise detected on the pulse signal prevents pulse discrimination.	Decrease patient motion, check sensor.
SpO <sub>2</sub> : Pulse Search	Hardware settings are being adjusted in order to discriminate a pulse waveform.	Change to site where pulse is stronger if patient is vasoconstricted. Change or readjust sensor if loose.
SpO <sub>2</sub> : No Pulse (Nellcor Only)	No detectable pulse is measured.	Check to patient connection and patient status.
SpO <sub>2</sub> : Failure	The system has detected an unrecoverable failure of the SpO <sub>2</sub> system.	Power cycle unit. If message reappears, call Mindray DS Service.
SpO <sub>2</sub> : Low Perfusion (Masimo Only)	Patient perfusion is low.	Check to patient connection and patient status.
SpO <sub>2</sub> : Too Much Light (Masimo Only)	There is too much ambient room light for the sensor to function properly.	Minimize the room light around the patient. Check sensor.
SpO <sub>2</sub> : Unrecognized Sensor (Masimo Only)	The sensor is not recognized by the Monitor.	Replace the sensor with a Mindray DS recommended sensor.
SpO <sub>2</sub> : Communication Error	The monitor and the SpO <sub>2</sub> modules are not communicating properly.	Power the unit OFF / ON. If problem persists, contact Mindray DS Service.
SpO <sub>2</sub> : Board Fault	Masimo board failed to operate properly.	Contact Mindray DS Customer Support.
SpO <sub>2</sub> : Sensor Fault	Defective Sensor.	Replace sensor.
SpO <sub>2</sub> : Motion (Nellcor Only)	Motion is detected.	Decrease patient motion, check sensor.
SpO <sub>2</sub> : Check Sensor (Nellcor Only)	The SpO <sub>2</sub> module has sensed a poor connection or a bad sensor.	Reconnect the same sensor. If problem persists, replace sensor.

### 3.22.3 Recorder Messages (only units equipped with recorder)

MESSAGE	REASON	ACTION
Local Printer Door Open	The door of the printer is not closed.	Close the printer door.
Local Printer Out Of Paper	The roll of printer paper is used up.	Replace with a new roll of paper.
Printer Busy	Printer received multiple print requests at one time.	Wait until the printer is not busy.
Local Printer Unable To Print	The system has detected an unrecoverable printer failure.	Power cycle unit. If message reappears, call Mindray DS Service.

### 3.22.4 CO<sub>2</sub> Messages (only units equipped with CO<sub>2</sub>)

MESSAGE	REASON	ACTION
CO <sub>2</sub> : Filterline Disconnected	The filterline is not connected to the monitor.	Connect the filterline.
CO <sub>2</sub> : Warming Up	The CO <sub>2</sub> sensor has not reached its operating temperature. (The monitor was just turned on)	Wait for the message to go away. It takes typically 30 seconds for the sensor to warm up.
CO <sub>2</sub> : Auto-zero In Progress	The CO <sub>2</sub> sensor is performing an auto-zero.	Wait for the auto-zero to complete.
CO <sub>2</sub> : Auto-zero Requested	An Auto-Zero was automatically requested by the system.	Wait for the auto-zero to complete.
CO <sub>2</sub> : Failure	CO <sub>2</sub> system failure.	Contact Mindray DS Technical Support.
CO <sub>2</sub> : Occlusion	The CO <sub>2</sub> hardware is indicating the sampling pump line is blocked while the CO <sub>2</sub> sidestream pump is on.	Check sampling line and filter for blockage, clear sampling line if possible. Replace sampling line if necessary. Disconnect and reconnect the filterline from the <b>Passport 2</b> in order to clear this message.
CO <sub>2</sub> : Purge	The system has detected a blocked filterline and attempts to unblock it by temporarily increasing the flow rate.	Check filterline and replace if necessary.

### 3.22.5 Passport 2 / Gas Module Messages (only observed when Gas Module is installed)

MESSAGE	REASON	ACTION
GM: Warming Up	Appears when the system has been turned on, and the sensors have not reached their stable operating temperature.	Wait for the message to go away. It takes up to two minutes for the device to warm up.
GM: Agent Warming Up	This message appears after the GMII: Warming Up message disappears. It indicates that the Agent ID Bench is warming up and readings will not be available.	Wait for the message to go away. It takes up to five minutes from power-up for the Agent ID Bench to warm up.
Does not apply to Gas Module 3.		

MESSAGE	REASON	ACTION
GM: Exhaust Blocked	Appears when the system detects a blockage at the exhaust gas outlet, as indicated by an increase in internal pressure.	Remove waste gas scavenging assembly, check if message disappears. Check exhaust line for blockage and clear if possible. If message persists, call Mindray DS service.
GM: Mixed Agents	Appears in Inverse Video when more than one anesthetic agent is detected by the system.	Message will disappear when a single agent is detected again.
GM: Air Leak	Appears when the system detects a pneumatic leak. Also may appear when the Gas Module has been turned on without a sample line attached or if the Gas Module has been on for a long period of time without the <b>Passport 2</b> Monitor being on.	Turn Gas Module and <b>Passport 2</b> Off. Install/check sample lines, filters, water trap and electrical connections. Turn on Gas Module and <b>Passport 2</b> Monitor.
GM: Replace Trap	Indicates residue build-up on the water trap membrane. This decreases air flow.	Replace water trap reservoir.
GM: Occlusion	Appears when the system detects an obstruction in the sampling line or the water trap bottle is full.	Empty and rinse water trap. Change water trap if necessary. Check sampling line and filter for blockage, clear sampling line if possible. Replace sampling line and/or filter if necessary. Check exhaust line for blockage and clear if possible. If problem persists, call Mindray DS service.
GM: Zero In Progress	Appears when the system is zeroing all of its channels. This appears whether initiated by the user or is automatic.	This is Normal Operation. Wait for message to clear.
GM: CO <sub>2</sub> Zero Error	Appears when the system has been unable to successfully zero the CO <sub>2</sub> sensor.	Manually start zeroing the system again. If problem persists, call Mindray DS service.
GM: O <sub>2</sub> Zero Error	Appears when the system has been unable to successfully zero the O <sub>2</sub> sensor.	Manually start zeroing the system again. If problem persists call for service.
GM: N <sub>2</sub> O Zero Error	Appears when the system has been unable to successfully zero the N <sub>2</sub> O sensor.	Manually start zeroing the system again. If problem persists call for service.
GM: Agent Zero Error	Appears when the system has been unable to successfully zero the Anesthetic Agent sensor.	Manually start zeroing the system again. If problem persists call for service.
GM: Pump Off	Appears when the system has turned off the pump due to a pneumatic error.	Restart the pump from the Gas Menu. If problem persists, call for service.
GM: Agent Mismatch - HAL	Appears when the system detects Halothane as the primary agent and the manually selected agent is not Halothane.	Match the Agent administered with the Agent selected, or select Agent Auto ID.
GM: Agent Mismatch - ISO	Appears when the system detects Isoflurane as the primary agent and the manually selected agent is not Isoflurane.	Match the Agent administered with the Agent selected, or select Agent Auto ID.

<b>MESSAGE</b>	<b>REASON</b>	<b>ACTION</b>
GM: Agent Mismatch - ENF	Appears when the system detects Enflurane as the primary agent and the manually selected agent is not Enflurane.	Match the Agent administered with the Agent selected, or select Agent Auto ID.
GM: Agent Mismatch - SEV	Appears when the system detects Sevoflurane as the primary agent and the manually selected agent is not Sevoflurane.	Match the Agent administered with the Agent selected, or select Agent Auto ID.
GM: Agent Mismatch - DES	Appears when the system detects Desflurane as the primary agent and the manually selected agent is not Desflurane.	Match the Agent administered with the Agent selected, or select Agent Auto ID.
GM: Unknown Agent	Appears when the system detects a gas that does not match the spectroscopic signatures of the five known anesthetic agents.	Use recognized agent.
GM: Cannot Zero... RETRYING	Appears when the Passport requests a Zeroing (either on the automatic cycle or by a user request), and the Gas Module is unable to initialize the cycle.	Allow system to retry without intervention. If problem persists call for service.
GM: ET CO <sub>2</sub> High	Appears when the End Tidal CO <sub>2</sub> measurement is greater than or equal to the value set for the ET CO <sub>2</sub> High Alarm.	Check patient.
GM: ET CO <sub>2</sub> Low	Appears when the End Tidal CO <sub>2</sub> measurement is less than or equal to the value set for the ET CO <sub>2</sub> Low Alarm.	Check patient.
GM: INSP CO <sub>2</sub> High	Appears when the FiCO <sub>2</sub> measurement is greater than or equal to the value set for the INSP CO <sub>2</sub> High Alarm.	Check patient.
GM: ET O <sub>2</sub> High	Appears when the End Tidal O <sub>2</sub> measurement is greater than or equal to the value set for the ET O <sub>2</sub> High Alarm.	Check patient.
GM: ET O <sub>2</sub> Low	Appears when the End Tidal O <sub>2</sub> measurement is less than or equal to the value set for the ET O <sub>2</sub> Low Alarm.	Check patient.
GM: INSP O <sub>2</sub> High	Appears when the FiO <sub>2</sub> measurement is greater than or equal to the value set for the INSP O <sub>2</sub> High Alarm.	Check patient.
GM: INSP O <sub>2</sub> Low	Appears when the FiO <sub>2</sub> measurement is less than or equal to the value set for the INSP O <sub>2</sub> Low Alarm.	Check patient.
GM: INSP N <sub>2</sub> O High	Appears when the Inspired N <sub>2</sub> O measurement is greater than or equal to the value set for the INSP N <sub>2</sub> O High Alarm.	Check patient.
GM: ET Agent High	Appears when the End Tidal Anesthetic Agent measurement is greater than or equal to the value set for the ET Agent High Alarm.	Check patient.
GM: ET Agent Low	Appears when the End Tidal Anesthetic Agent measurement is less than or equal to the value set for the ET Agent Low Alarm.	Check patient.



MESSAGE	REASON	ACTION
GM: INSP Agent High	Appears when the Inspired Agent measurement is greater than or equal to the value set for the INSP Agent High Alarm.	Check patient.
GM: INSP Agent Low	Appears when the Inspired Agent measurement is less than or equal to the value set for the INSP Agent Low Alarm.	Check patient.
GM: CO <sub>2</sub> Uncalibrated	Appears after an unsuccessful calibration attempt of the CO <sub>2</sub> sensor. The numeric data for CO <sub>2</sub> will appear as ---, and the CO <sub>2</sub> waveform will be a flatline.	Ensure proper gas mixture is attached tightly and regulator is on. Repeat calibration procedure. If problem persists, call for service.
GM: O <sub>2</sub> Uncalibrated	Appears after an unsuccessful calibration attempt of the O <sub>2</sub> sensor. The numeric data for O <sub>2</sub> will appear as ---, and the O <sub>2</sub> waveform will be a flatline.	Ensure proper gas mixture is attached tightly and regulator is on. Repeat calibration procedure. If problem persists, call for service.
GM: N <sub>2</sub> O Uncalibrated	Appears after an unsuccessful calibration attempt of the N <sub>2</sub> O sensor. The numeric data for N <sub>2</sub> O will appear as ---, and the N <sub>2</sub> O waveform will be a flatline.	Ensure proper gas mixture is attached tightly and regulator is on. Repeat calibration procedure. If problem persists, call for service.
GM: Agents Uncalibrated	Appears after an unsuccessful calibration attempt of the Agent sensor. The numeric data for all agents will appear as ---, and the agent waveform will be a flatline.	Ensure proper gas mixture is attached tightly and regulator is on. Repeat calibration procedure. If problem persists, call for service.
GM: Failed	Appears when the Gas Module detects an unrecoverable error in its own operation.	Call for Service.
GM: Disconnected	Appears when the <b>Passport 2</b> cannot detect signals being sent by the Gas Module.	Ensure Gas Module is turned on and interface cable is properly connected. If problem persists, call for service.
Sampling Error	Appears when a sampling error occurs on one or more Gas Module channels during calibration.	Repeat calibration procedure. If problem persists, call for service.
Calibration Not Started	Appears when the Gas Module is unable to initialize calibration.	Repeat calibration procedure. If problem persists, call for service.
Calibration Error, Sampling Error	Appears when a sampling error occurs in all four Gas Module channels during calibration.	Repeat calibration procedure. If problem persists, call for service.
Calibration Error, Zeroing Error	Appears when the Gas Module cannot perform a Zero during calibration.	Repeat calibration procedure. If problem persists, call for service.

### 3.22.6 Cooling Fan Message

MESSAGE	REASON	ACTION
Cooling Fan Failure	Either an over-temperature condition exists or the unit is running on AC Power and a fan failure has been detected.	Call for service.

## 3.23 Monitor Problem Solving

This guide is provided to establish the possible causes and solutions to some monitoring problems.

<b>PROBLEM</b>	<b>REASON</b>	<b>ACTION</b>
No trace for a desired parameter	Improper attachment of transducer to monitor	Check transducer connection
	Faulty transducer	Try a different transducer
Wandering ECG	Respiration artifact	Try a different base line lead configuration
Noisy ECG traces	Loose or dry electrodes	Apply new electrodes
	Defective electrode wires	Replace wires as necessary
	Patient cable or leads are routed too close to other electrical devices	Eliminate 60Hz interference Use ECG cable with built-in filter block
Low Amplitude ECG	Electrode could be positioned over a bone or muscle mass	Reposition electrodes Press <b>ECG SIZE</b> key
Excessive Electro-surgical Interference	Inadequate skin prep prior to application of electrode	Repeat skin prep and electrode placement procedures Add additional gel to electrodes
Intermittent Signal	Connections not tight and properly secured	Ensure proper connection (Electrode to lead, lead to cable, cable to monitor)
	Electrodes dry	Re-prep skin and apply fresh moist electrodes
	Cable or leadwires damaged	Check with continuity tester
Excessive alarms: heart rate, lead fault	Electrodes dry	Re-prep skin and apply fresh, moist electrodes
	Alarm limits set too close to patient's normal heart rate	Readjust
	R-wave wrong size	Must be twice the amplitude of other part of waveform
	Excessive patient movement or muscle tremor	Reposition electrodes and secure with tape if necessary
Low Amplitude ECG Signal	Gain set too low. (Set through <b>SIZE</b> key.	Readjust as required
	Skin improperly prepared	Abrade skin
	Possibly not patient's normal complex	Check with 12 lead electrocardiogram
	Electrode could be positioned over a bone or muscle mass	Reposition electrodes
Trace Not Moving	<b>FREEZE</b> key may have been pressed.	Press the <b>FREEZE</b> key to unfreeze the trace
Temperature Probes not Working	Poor contact from probes to body	Check the body surface contact at the probe tip. Reposition or apply thermoconductive gel.

<b>PROBLEM</b>	<b>REASON</b>	<b>ACTION</b>
Display Appears to be Off	Mains power switch may not be on	Check mains power switch on side panel
	Unit may not be plugged into an AC outlet	Check power cord (Is it plugged in?)
	If used as a portable, battery pack may be drained	If battery pack is drained, plug into an AC outlet to recharge the battery. A period of 5 hours is required for a full charge of lithium-ion batteries. A period of 16 hours is required for a full charge of sealed lead acid batteries.
Disabled Alarm Tone, QRS Tone, or Other Function	<b>MUTE</b> key pressed	Check for alarm mute symbol and message
	Beep volume low	Increase beep volume
ECG Base Line With No Waveform	Gain control not set high enough. Set through <b>SIZE</b> key	Readjust as required
	Leadwires and patient cable not fully inserted into proper receptacle	Check insertion
	Cable or leadwires damaged	Check with lead continuity tester
Base Line Wander	Patient moving excessively	Secure leadwires and cable to patient
	Patient's respiration	Reposition electrodes
	Electrodes dry	Re-prepare skin and apply fresh moist electrodes
	Static build up around patient	Check with hospital engineer
Damped Invasive Waveform	Air bubbles in tubing	Eliminate air from tubing
	Kinked catheter	Slightly alter position of catheter
	Catheter against wall of blood vessel	Check for leaks at connector
	Blood in tubing	Pump pressure bag up to 300 mmHg
Recorder Report Appears Totally Blank	Thermal paper may be installed incorrectly (up-side down)	Remove paper and re-install with paper feeding off of the spool from the bottom
Resp. Waveform Too Large	Scales set inappropriately	Change lead selection
Resp. Waveform Too Small	Patient breathing shallow or turned on side	Change lead selection
	Scale set inappropriately	
False Apnea Alarm	Apnea delay may be improperly set	Choose another apnea delay set
	Patient may be having frequent episodes of CVA	Reposition electrodes to better detect respirations
	Scale size may be too low	

<b>PROBLEM</b>	<b>REASON</b>	<b>ACTION</b>
"CHK Lead" Message	Due to increased impedance	Prep chest
	Chest hair under electrodes	
	Dried electrode gel	Change electrodes
	Electrode off	Replace electrode
	Lead off	Replace lead
	Cracked leadwires	Replace leadwires
"CVA" Message	Poor skin prep	Clean and abrade skin before applying electrodes
	Can be caused by shallow breathing or an apnea event	Check the patient adjust scales or leads if necessary
No Resp. Waveform or Rate Displayed	Patient not connected to a patient safety cable	Turn respiration on ( <b>OFF</b> will be displayed in Resp. window). Check that proper patient cable is used
	Patient connected using Patient ESIS Choke/Cable	Use 3-lead Patient Cable - non ESIS. (See Accessories, Section 5.1.)
"BAD CARD" Message	The option card is not the correct version or the card data has become corrupt.	Obtain replacement card
"Artifact" Message	The 12 Lead ECG is detecting muscle artifact, or electrical interference from auxiliary devices.	Check leads, follow skin preparation procedure (see 3.5.2) Check for electrical interferences, replace wires as necessary

## 3.24 Connection to Visa or PatientNet Central Stations

The **Passport 2** can be connected to the VISA or PatientNet Central Stations via direct hardwire or telemetry connection with the COMM Port. Access the "Installation Menu" (See section 3.2.1) and set a serial port to "Visa with admit" in order to enable the VISA Interface or "PatientNet" to enable PatientNet.

The interface allows the **Passport 2** waveforms and data to be displayed at the VISA or PatientNet Central Stations. The interface also enables the **Passport 2** to admit to, discharge from, and print at the VISA or PatientNet Central Stations.

**NOTE:** See the **VISA Operating Instructions for more details on VISA operation.**

**NOTE:** See the **PatientNet Operating Instructions for more details on PatientNet Operation.**

**NOTE:** See the **Administrative Guide for the PatientNet Central Station for more details on PatientNet Operation.**

## 3.25 Connection to Panorama™ Central Station

The **Passport 2** will communicate with the Panorama Central Station via direct hardwire to an appropriate Comm-Port or via a wireless network. The "Enable Network" option in the System Information menu must be set to "Wired" when using a hardwire **Passport 2**. "Enable Network" must be set to "Wireless" for communication between the **Passport 2** and the Panorama via the 2.4 GHz wireless Symbol radio card. "WMTS Enabled" must be set to "Yes" to allow for communication between the **Passport 2** and the Panorama via the Panorama Instrument Radio - 608.

Refer to the Panorama Operating Instructions Manual for a list of supported parameters.

The Passport 2 is capable of transmitting a discharge command to a Panorama Central Station. It is also capable of bi-directional transmission of patient demographics and patient alarm settings with a Panorama Central Station.

When the Panorama Central is selected for operation, the Patient Discharge menu selections will vary as follows:

- For Main Module Software Versions Y.xx and earlier, "Discharge From Central" and "Discharge From Both" will be displayed.
- For Main Module Software Versions AA.xx and later, "Discharge From Both" will be displayed.

When "Discharge From Central" or "Discharge From Both" are selected from the Patient Discharge menu, the Panorama will discharge the patient.

If Trend is cleared or the patient is discharged at the Passport 2, the Passport time and date will be synchronized with the Panorama Central Station time and date.

**NOTE:**      **If a Passport 2 608 radio is communicating with a Panorama Central Station, Gas Module data and alarms, V2 - V6 waveform data and ST templates are not displayed at the Central Station.**

## 3.26 Connection to Panorama™ Gateway

The **Passport 2** can communicate with an EMR system through a Panorama Gateway via a hardwired network connection to a Comm-Port with a CS1 port or via wireless connection through a Panorama Central Monitoring System. The "Enable Network" option in the **Passport 2** System Information menu must be set to "Wired" when using a hardwire **Passport 2**. "Enable Network" must be set to "Wireless" to allow for wireless communication through a Panorama Central Station via the 2.4 GHz wireless Symbol radio card. "WMTS Enabled" must be set to "Yes" to allow for wireless communication through a Panorama Central Station via the Panorama Instrument Radio - 608.

For the **Passport 2** to be recognized by the EMR system, certain demographics content, referred to as the "Patient Key", must be entered from its Patient Menu. Each facility has its own unique "Patient Key" that must be entered before making a connection to the EMR. The "Patient Key" consists of the required ID # and, optionally, one or more of the following Patient Menu demographics fields:

- First name
- Last name
- Bed #

Once the "Patient Key" has been entered, communication with the EMR system must be verified. Since the Panorama Gateway can be purchased with ADT messaging only, Results messaging only or ADT messaging with Results messaging, this verification differs as follows:

### ADT messaging

For a Panorama Gateway that has ADT messaging, verify that communication with the EMR system has been established as follows:

- After entering the "Patient Key" in the Patient Menu, select Normal Screen to close the menu.
- If demographics information corresponding to the following fields was not part of the "Patient Key" but is entered into the EMR system, these fields in the Patient Menu should auto-populate upon re-opening the menu:
  - First name
  - Last name
  - Bed #
  - Date of Birth
  - Gender
- In addition, the First Name and Last Name should populate in the upper right of the display.
- If the fields do not auto-populate, verify that the "Patient Key" has been correctly entered and that the patient demographics have been entered in the EMR system. If the fields still do not auto-populate, contact the EMR administrator.

### Results messaging

For facilities with a Panorama Gateway that has Results messaging, verify that communication with the EMR system has been established by checking the charting system to ensure that vital signs data has been uploaded. If the charting system is not displaying the information, contact the EMR administrator.

---

### 4.1 Introduction

This section of the manual outlines routine maintenance that should be performed by the user.

The **Passport 2/Passport 2 LT** Monitor is designed for stable operation over long periods of time and under normal circumstances should not require technical maintenance beyond that described in this section. However, it is recommended that routine maintenance calibration and safety checks be performed at least once a year or more often as required by local statutory or hospital administration practice.

### 4.2 Care and Cleaning of Monitor

The monitor enclosure may be cleaned with a mild soap and water solution or ammoniated window cleaner. Apply cleaning solution to the cloth, not directly onto the monitor. DO NOT apply large amounts of liquid. DO NOT use abrasive cleaning agents or organic solvents.

**WARNING: Do not clean the monitor while it is on and/or plugged in.**

To prevent scratches on the front panel display screens, blow or carefully brush dust and dirt particles with a soft sponge moistened with cleaner solution; or a fine, soft-hair brush. DO NOT use abrasive cleaning materials. Fingerprints and stains may be removed by using a liquid lens cleaner and a soft cloth. DO NOT wipe a dry screen or use alcohol or chlorinated hydrocarbon solvents.



## 4.3 Decontamination of Monitor

**WARNING:** Perform the decontamination process with the unit powered down and power cord removed.

Decontamination of a unit that has come in contact with a biological material can be performed using LpH SE Germicidal detergent. Apply a small amount of detergent to a disposable wipe (paper based) and wipe down the outside of the unit. Discard the wipe appropriately. After waiting 10 minutes, use a clean dry wipe to dry the unit.

**CAUTION:** During the decontamination process, do not get the LpH SE Germicidal detergent into any vent openings.

## 4.4 Care and Cleaning of SpO<sub>2</sub> Sensors

**NOTE:** Refer to the individual instruction sheets that are packaged with each sensor.

- Daily, check the sensors and cables for signs of damage. Replace as required.
- The sensors should be cleaned before and after each patient's use.
- Wipe the patient contact area using a soft cloth with mild soap and water solution or isopropyl alcohol. Hydrogen peroxide can be used to remove dried blood on all accessible surfaces.
- Let the sensor completely dry before using.

**CAUTION:** When cleaning SpO<sub>2</sub> sensors, do not use excessive amounts of liquid. Wipe the sensor surface with a soft cloth, dampened with the cleaning solution.

## 4.5 Sterilization and Cleaning of Reusable Bladderless Cuffs

Clean cuffs with warm water and a mild detergent. Do not use a detergent containing hand conditioners, softeners, or fragrances.

NIBP cuffs can be sterilized with gamma sterilization without effecting the repeated performance of the cuff. Steam sterilization is not recommended. Use of a washing liquid containing bleach is not recommended because chlorine will chemically break down the urethane on the inside of the cuff.

### Antimicrobial Definition

Mindray DS bladderless cuffs are treated with an antimicrobial coating. Antimicrobial technology effectively controls a broad spectrum of bacteria, fungi, algae and yeasts on a wide variety of treated substrates.

## 4.6 Battery Replacement and Maintenance

### 4.6.1 Battery Replacement

1. Open battery compartment door, on left side of unit, by pressing the finger grip area and sliding the door to the left.
2. Press the release button, located on the right side of the installed battery. This will eject the battery. Slide out old battery.
3. Slide in replacement battery until it clicks into place.
4. Close battery compartment door by sliding the door to the right until it firmly clicks into place.

**CAUTION:** Replace sealed lead acid batteries with Mindray DS P/N 0146-00-0043 ONLY. Replace lithium-ion batteries with Mindray DS P/N 0146-00-0069 ONLY.

### 4.6.2 Battery Maintenance

The batteries may be subject to local regulations regarding disposal. At the end of the battery life, dispose of the batteries in accordance with any local regulations.

**CAUTION:** Recharge batteries in the Passport 2/Passport 2 LT.

**CAUTION:** Remove the batteries if the Passport 2/Passport 2 LT is not likely to be used for an extended period of time.

#### Sealed Lead Acid

Due to the self-discharge characteristics of sealed lead acid batteries, it is imperative that they are charged after 3 months of storage (or unit not in use). If not, permanent loss of capacity may occur as a result of sulfation. Charge retention at 20°C is 6 months to 83%.

#### Lithium-Ion

Storage of the lithium-ion batteries depends on temperature, time period and the degree of cell charging state. After 6 months of storage at 23°C, fully charged lithium-ion batteries have a retention capacity of 93%.

## 4.7 Recorder Paper Replacement

The instructions below describe the replacement of recorder paper. Use only recommended recorder paper, P/N 0683-00-0422-XX. This ensures that the print quality is acceptable and reduces print head wear.

1. Open recorder door by pressing the paper eject button.

**NOTE:**       **If the recorder door does not open completely, carefully pull it until it is completely open.**

2. Remove empty paper spool by pulling it out gently.
3. Insert new paper roll between the two rounded tabs of the paper holder with the sensitive (shiny) side of the paper facing the print head at the top of the recorder (paper feeding off of the spool from the bottom).
4. Unroll approximately 4 inches of paper.
5. Align the paper across the top of the metal bar.
6. Holding the paper in place, close recorder door.
7. To ensure that the paper is aligned properly and has not been pinched in the door, pull the loose edge out a couple of inches. If the paper jams, open the door and return to step 5.

## 4.8 Care and Storage of Thermal Chart Paper

Thermal Chart Paper is chemically treated and the permanency of a recording is affected by storage and handling conditions. These conditions are:

- Ultraviolet Light  
We recommend storing the recordings in a filing cabinet within a few days of printing. Long term exposure to natural or artificial U.V. sources may be detrimental.
- Storage Temperature and Humidity  
Keep the recordings in a cool and dry area for a longer lasting image. Extreme temperature and humidity (above 80° F and 80% Humidity) should be avoided.
- Solvent Reactions  
Do not store the recordings in plastic bags, acetate sheet protectors, and similar items made from petroleum products. These products emit a small amount of vapor which will, over a period of time, deteriorate the image on the chart paper.
- Adhesive Tape  
Never place adhesive tape over recordings. The reaction between the adhesive compound and the Chemical/Thermal paper can destroy the image within hours.
- Archives  
We recommend that if long term archives are required, make a photocopy of the recordings as back-up. Under normal office filing conditions the recordings should retain acceptable image quality for about 5 years.

## 4.9 Care and Cleaning of Gas Module

### 4.9.1 Gas Module II and Gas Module SE

**WARNING:** Do not clean the Gas Module while it is on and/or plugged in.

1. The Gas Module enclosure may be cleaned with a mild soap and water solution or ammoniated window cleaner. Apply cleaning solution to the cloth, not directly onto the Gas Module. DO NOT apply large amounts of liquid. DO NOT use abrasive cleaning agents or organic solvents.

**CAUTION:** The internal sampling system of the Gas Module does not need to be cleaned or sterilized. There is no reverse flow back to the patient. If the internal sampling system is suspected to be clogged or dirty, the module should be serviced by an authorized service person only.

2. The fan dust filter should be checked and cleaned on a regular basis, at least once every two months.
  - Locate fan on front panel.
  - Remove the filter by pulling the dust filter cover.
  - Remove the dust from the filter.
  - Let the filter soak in a mild detergent solution.
  - Rinse the filter and let dry completely before re-installing.

**CAUTION:** If the dust filter for the fan cannot be cleaned or is damaged, replace it with part number 0378-00-0040. Use of another type of filter may decrease the cooling effectivity and cause damage to the Gas Module.

3. The Water Trap Reservoir must be checked and emptied whenever changing patients or if it is more than half full.
  - To remove the water trap, push the water trap latch to the right. The water trap is spring loaded and will pop out. An **Air Leak** message will be displayed. The monitor will suspend sampling.
  - Detach the reservoir from the water trap assembly by pulling it down carefully.
  - Empty the reservoir and rinse with water only.
  - Re-attach the reservoir to the assembly tightly.
  - Re-install the whole unit into the Gas Module making sure the latch is set. Check that the **Air Leak** message disappears and monitoring resumes.

**NOTE:** Do not disinfect or open the water trap. If an "occlusion" message appears, it may be necessary to replace the water trap assembly P/N 0202-00-0129.

**NOTE:** The Water Trap Assembly must be replaced every two months.

## 4.9.2 Gas Module 3

**WARNING: Do not clean the Gas Module while it is on and/or plugged in.**

1. The Gas Module enclosure may be cleaned with a mild soap and water solution or ammoniated window cleaner. Apply cleaning solution to the cloth, not directly onto the Gas Module. DO NOT apply large amounts of liquid. DO NOT use abrasive cleaning agents or organic solvents.

**CAUTION: The internal sampling system of the Gas Module does not need to be cleaned or sterilized. There is no reverse flow back to the patient. If the internal sampling system is suspected to be clogged or dirty, the module should be serviced by an authorized service person only.**

2. The DRYLINE™ Water Trap Assembly consists of a filter housing and reservoir that must be checked and emptied whenever changing patients or if it is more than half full.

**WARNING: The contents of the water trap should be handled as a potential infection hazard.**

**NOTE: Replace the complete DRYLINE™ Water Trap Assembly every month or more often if indicated on the monitor.**

- To remove the DRYLINE™ Water Trap Assembly from its receptacle, press the lugs on its sides and pull out. An **Air Leak** message will be displayed. The monitor will suspend sampling.
- Detach the reservoir from the filter housing by twisting and separating these two parts.
- Empty the reservoir and rinse with water only.
- Tightly re-attach the reservoir to the filter housing.
- Re-install the DRYLINE™ Water Trap Assembly into the Gas Module, ensuring that it snaps into place. Check that the **Air Leak** message disappears and monitoring resumes.

**NOTE: Only the reservoir of the DRYLINE™ Water Trap Assembly may be cleaned and/or disinfected.**

**NOTE: If an "Occlusion" message appears, it may be necessary to replace the DRYLINE™ Water Trap Assembly (Adult/Pediatric P/N 0202-00-0182-10; Neonate P/N 0202-00-0181-10).**

## 4.10 Care and Cleaning of 3 Lead and 5 Lead ECG Cables and Leadwires

Recommended cleaning method of ECG cables and leadwires is a cloth wipe using ordinary alcohol-free hand soap or USP green soap tincture. When disinfection is required, a cloth wipe using disinfectants such as isopropyl alcohol, chlorine bleach in water (1:10 mixture) or 2% Glutaraldehyde solution (i.e., Cidex) is recommended. After cleaning, the ECG cables and leadwires should be wiped with water using a clean damp cloth then dried with a clean dry cloth.

**CAUTION:** To avoid permanent damage, do not expose metal components (pins, sockets, snaps) to disinfectants, soaps or chemicals.

**NOTE:** ECG cables and leadwires must never be immersed, soaked in any fluids, and they should not be cleaned with harsh chemicals such as acetone or non-diluted bleach.

**NOTE:** Do not autoclave, radiation or steam sterilize ECG cables or leadwires.

**NOTE:** Extended exposure to Ethylene Oxide gas may shorten life of the ECG cables and leadwires, leading to poor signal quality.

## 4.11 Care and Cleaning of View 12™ ECG Cables and Leadwires

Clean cables and leadwires using a cloth wipe and warm water. Use a dry, clean cloth to dry leadwires and cables before placing them on a patient. Do not use alcohol to clean the View 12™ ECG Analysis Module. Alcohol or other harsh chemicals will cause the cables and leadwires to become brittle or harden, causing damage.

**NOTE:** The View 12™ ECG Analysis Module must never be immersed or soaked in any fluids.

If the M-12 cable or PC card require maintenance or service, please contact the Mindray DS Service department at 1-800-288-2121.

**This page intentionally left blank.**

## 5.1 Optional Accessories

### 5.1.1 NIBP Accessories

#### Hoses/Adapters

DESCRIPTION	PART NUMBER
NIBP Hose, 60" (1.5 m), Female Rectus to Female Rectus	0683-04-0003
NIBP Hose, 138" (3.5 m), Female Rectus to Female Rectus	0683-04-0004
NIBP Hose, Neonate 60" (1.5 m), Female Luer to Female Rectus (for use with disposable neonate cuffs)	0683-04-0005

#### Color Coded Reusable Cuffs (with Quick-Connect fittings)

DESCRIPTION	PART NUMBER
Variety Kit I, 6 cuffs [(1) Small Child, (1) Child, (1) Small Adult, (1) Adult, (1) Large Adult, (1) Adult Thigh]	0020-00-0082-31
Variety Kit II, 6 cuffs [(1) Small Adult, (2) Adult, (2) Large Adult, (1) Adult Thigh]	0020-00-0082-33
Variety Kit III, 6 cuffs [(1) Small Child, (2) Child, (3) Small Adult]	0020-00-0082-32
Adult Thigh, Brown (45 - 56.5 cm circumference)	0998-00-0003-56
Large Adult Long, Burgundy (35.5 - 46 cm arm circumference)	0998-00-0003-58
Large Adult, Burgundy (35.5 - 46 cm arm circumference)	0998-00-0003-55
Adult Long, Navy Blue (27.5 - 36.5 cm arm circumference)	0998-00-0003-57
Adult, Navy Blue (27.5 - 36.5 cm arm circumference)	0998-00-0003-54
Small Adult, Light Blue (20.5 - 28.5 cm arm circumference)	0998-00-0003-53
Child, Green (13.8 - 21.5 cm arm circumference)	0998-00-0003-52
Small Child, Orange (9 - 14.8 cm arm circumference)	0998-00-0003-51



## Disposable Cuffs (with Quick-Connect fittings)

DESCRIPTION	PART NUMBER
Adult Thigh, White/Brown (5/box) (45 - 56.5 cm circumference)	0683-07-0036-01
Large Adult Long, White/Burgundy (10/box) (35.5 - 46 cm arm circumference)	0683-07-0038-01
Large Adult, White/Burgundy (10/box) (35.5 - 46 cm arm circumference)	0683-07-0035-01
Adult Long, White/Navy Blue (10/box) (27.5 - 36.5 cm arm circumference)	0683-07-0037-01
Adult, White/Navy Blue (10/box) (27.5 - 36.5 cm arm circumference)	0683-07-0034-01
Small Adult, White/Light Blue (10/box) (20.5 - 28.5 cm arm circumference)	0683-07-0033-01
Child, White/Green (10/box) (13.8 - 21.5 cm arm circumference)	0683-07-0032-01
Small Child, White/Orange (10/box) (9 - 14.8 cm arm circumference)	0683-07-0031-01

## Disposable Neonatal NIBP Cuffs - Quick Connect\*

DESCRIPTION	PART NUMBERS
Neonatal Size 1: limb circumference 3 – 6 cm, Box of 10	0683-13-0001-01
Neonatal Size 2: limb circumference 5 – 8 cm, Box of 10	0683-13-0002-01
Neonatal Size 3: limb circumference 7 – 10 cm, Box of 10	0683-13-0003-01
Neonatal Size 4: limb circumference 9 – 13 cm, Box of 10	0683-13-0004-01
Neonatal Size 5: limb circumference 12 – 17 cm, Box of 10	0683-13-0005-01

\* Disposable neonatal cuffs require NIBP hose part number 0683-04-0003 (1.5 m).

### 5.1.2 Oximetry Sensors and Accessories

#### 5.1.2.1 Pulse Oximetry-Masimo SET<sup>®</sup> LNOP<sup>®</sup> SpO<sub>2</sub>

DESCRIPTION	PART NUMBER
LNOP <sup>®</sup> DCI Adult/Pediatric starter kit (one reusable adult sensor, 2 adult and 1 pediatric single patient adhesive sensors and one 12' cable)	0020-00-0130
LNOP <sup>®</sup> DCI-Adult reusable finger sensor (with added "flaps" for ambient light shielding and 3' cable)	0600-00-0047
LNOP <sup>®</sup> DC-12 Adult direct connect reusable finger sensor with attached 12' cable	0600-00-0120
LNOP <sup>®</sup> DCIP-Pediatric/slender digit reusable finger sensor	0600-00-0063
LNOP <sup>®</sup> TCI Tip Clip Ear Sensor	0600-00-0110
Ear Clip	0600-00-0086
Ear Hanger (pkg of 5)	0600-00-0087
LNOP <sup>®</sup> YI-Multisite reusable sensor	0600-00-0078
Multisite wrap (box of 100)	0600-00-0081
Multisite wrap, foam (pkg of 12)	0600-00-0083
LNOP <sup>®</sup> DCSC-Adult spot check reusable sensor	0600-00-0077
PC08-SpO <sub>2</sub> cable (2.44 m./8')	0012-00-1099-01
PC12-SpO <sub>2</sub> cable (3.66 m./12')	0012-00-1099-02

DESCRIPTION	PART NUMBER
LNOP® Adt-Adult single patient adhesive sensors for patients more than 30 kgs. (pkg of 20)	0600-00-0043-01
LNOP® Pdt-Pediatric/slender digit single patient sensors for patients more than 10 kgs. and less than 50 kgs. (pkg of 20)	0600-00-0044-01
LNOP® II Inf-L-Infant L single patient adhesive sensors for patients more than 3 kgs. and less than 10 kgs. (pkg of 20)	0600-00-0100
Tape, Infant, L-Series (Package of 100)	0600-00-0108
LNOP® Neo-Neonatal Y single patient adhesive sensors for patients more than 1 kg. and less than 10 kgs. (pkg of 20)	0600-00-0045-01
Adhesive tapes for Neonatal Y single patient adhesive sensors (pkg of 100)	0600-00-0065
LNOP® II Neo-Neonatal L single patient adhesive sensors for patients more than 1 kg. and less than 10 kgs. (pkg of 20)	0600-00-0099
Adhesive tapes for Neonatal L single patient adhesive sensors (pkg of 100)	0600-00-0096
LNOP® NeoPt-Preterm neonatal Y single patient adhesive sensors-for patients less than 1 kg. (pkg 20)	0600-00-0046-01
Posey wraps for Preterm neonatal Y single patient adhesive sensors (pkg of 12)	0600-00-0064
LNOP® II NeoPt-L-Preterm neonatal L single patient adhesive sensors-for patients less than 1 kg. (pkg 20)	0600-00-0098
Posey wraps for Preterm neonatal L single patient adhesive sensors (pkg of 12)	0600-00-0097
Adult/Pediatric starter kit (two adult and two pediatric single patient adhesive sensors and one 3.66 m./12' cable)	0020-00-0123-01
Neonatal Y starter kit (two neonatal and two preterm neonatal Y single patient adhesive sensors and one 3.66 m./12' cable)	0020-00-0123-02
Clothing clips (pkg of 5)	0600-00-0084
Adhesive squares (12 cards/12 squares per card)	0600-00-0085

### 5.1.2.2 Pulse Oximetry-Masimo Set® LNCS® SpO<sub>2</sub>

DESCRIPTION	PART NUMBER
LNCS DC-I Adult finger reusable sensor	0600-00-0126
LNCS DC-IP Pediatric finger reusable sensor	0600-00-0127
LNCS TC-I, Reusable Adult Ear Sensor	0600-00-0128
LNCS ADTX Adult single patient adhesive sensors (20/Box)	0600-00-0121
LNCS PDTX Pediatric single patient adhesive sensors (20/Box)	0600-00-0122
LNCS INF-L Infant single patient adhesive sensors (20/Box)	0600-00-0123
LNCS NEO-L Neonatal single patient adhesive sensors (20/Box)	0600-00-0124
LNCS NEO PT-L Neonatal preterm patient adhesive sensors (20/Box)	0600-00-0125
LNCS-4 SpO <sub>2</sub> Patient cable, 4'	0012-00-1652
LNCS-10 SpO <sub>2</sub> Patient cable, 10'	0012-00-1599
LNCS-14 SpO <sub>2</sub> Patient cable, 14'	0012-00-1653
LNCS to LNOP PC series adapter	0012-00-1651
Masimo SET AC-1 LNCS adapter cable	0012-00-1656
LNCS Adult/Pediatric starter kit (one reusable Adult sensor, 2 Adult and 1 Pediatric single patient adhesive sensor and one 3.1 m cable)	0020-00-0154

DESCRIPTION	PART NUMBER
LNCS Neonatal disposable starter kit (2 Neonate and 2 Neonate PreTerm single patient adhesive sensors and one 3.1 m cable)	0020-00-0155
LNCS Adult/Pediatric disposable starter kit (2 Adult and 2 Pediatric single patient adhesive sensors and one 3.1 m cable)	0020-00-0156

### 5.1.2.3 Pulse Oximetry-Nellcor® OxiMax® SpO<sub>2</sub>\*

DESCRIPTION	PART NUMBER
Reusable sensor	0600-00-0051
SpO <sub>2</sub> cable, DOC-10, OxiMax	0012-00-1464
Disposable OxiMax Sensor Kit (2 adult/2 neonatal)	0600-00-0103

\* *Oximetry-Nellcor® OxiMax® SpO<sub>2</sub> Replacement sensors are available from Nellcor-Puritan Bennett. Phone: 1 800 NELLCOR or WWW.NELLCOR.COM*

### 5.1.3 Oridion CO<sub>2</sub> Accessories

DESCRIPTION	PART NUMBER
Filterline Set (short term), Adult/Pediatric (box of 25)	0683-00-0470-25
Filterline Set, High Humidity, Infant/Neonatal (box of 25)	0683-00-0490-25
Filterline Set, High Humidity, Adult/Pediatric (box of 25)	0683-00-0469-25
Smart CapnoLine™ Nasal/Oral Cannula, Pediatric (box of 25)	0683-00-0495-25
Smart CapnoLine™ O <sub>2</sub> /CO <sub>2</sub> Oral Nasal Cannula Adult (box of 25)	0683-00-0496-25
Smart CapnoLine™ O <sub>2</sub> , Nasal/Oral Cannula, Pediatric (box of 25)	0683-00-0498-25
Smart CapnoLine Plus™ O <sub>2</sub> /CO <sub>2</sub> Oral Nasal Cannula with O <sub>2</sub> tubing, Adult/Intermediate (box of 25)	0683-00-0516-25
Smart CapnoLine Plus™ O <sub>2</sub> /CO <sub>2</sub> Oral Nasal Cannula with O <sub>2</sub> connector, Adult/Intermediate (box of 25)	0683-00-0517-25
NIV Line™, Adult (box of 25)	0683-00-0506-25
NIV Line™, Pediatric (box of 25)	0683-00-0507-25
CapnoLine™ H, Adult (box of 25)	0683-00-0508-25
CapnoLine™ H, Pediatric (box of 25)	0683-00-0509-25
CapnoLine™ H, Infant/Neonatal (box of 25)	0683-00-0510-25
CapnoLine™ H O <sub>2</sub> , Adult (box of 25)	0683-00-0511-25
CapnoLine™ H O <sub>2</sub> , Pediatric (box of 25)	0683-00-0512-25
Calibration Gas	0075-00-0033-01
CO <sub>2</sub> Exhaust Connector, Male	0008-00-0332-01

## 5.1.4 Gas Module Accessories

### 5.1.4.1 Gas Module II and Gas Module SE

DESCRIPTION	PART NUMBERS
Calibration Gas	0075-00-0028
Calibration Gas Regulator	0119-00-0166
Gas Module Rolling Stand Kit	0040-00-0232-01
Gas Module Wall Mount Kit	0040-00-0232-02
Y-Power Cord, North America, 120V	0012-00-1081-01
Dust Filter	0378-00-0040
Nasal Cannula, CO <sub>2</sub> , 7' (box of 10)	0683-00-0424-10
Nasal Cannula, CO <sub>2</sub> /O <sub>2</sub> , 7' (box of 10)	0683-00-0452-10
Adapter, Straight Tee ET (box of 12)	0683-00-0242-22
Adapter, Mask Elbow ET (box of 12)	0683-00-0242-12
Sample Line, Patient, 10' (box of 10)	0683-00-0451-10
Water Trap Assembly (box of 10)	0202-00-0129
Gas Scavenging Adapter Assembly, Quick Connect	0997-00-0923
Gas Scavenging Adapter Assembly, Luer	0997-00-0984
Passport 2/Gas Module Mounting Kit	0040-00-0287-03

### 5.1.4.2 Gas Module 3

DESCRIPTION	PART NUMBERS
Calibration Gas	0075-00-0028
Calibration Gas Regulator	0119-00-0166
Mounting Bracket, Gas Module to Passport 2 (includes 4 screws, Part Number 0212-17-0606)	0040-00-0299-02
Mounting Plate, Gas Module to Wall Mount (includes 4 screws, Part Number 0211-03-5008)	0386-00-0344
Mounting Plate, Gas Module to Passport 2 (requires 4 screws, Part Number 0211-04-4010)	0436-00-0160
Y-Power Cord, North America, 120V	0012-00-1081-01
Cable, Gas Module to Passport 2 Serial Port, short (1')	0012-00-1276-01
Cable, Gas Module to Passport 2 Serial Port, long (6')	0012-00-1276-02
Nasal Cannula, CO <sub>2</sub> , 7' (box of 10)	0683-00-0424-10
Nasal Cannula, CO <sub>2</sub> /O <sub>2</sub> , 7' (box of 10)	0683-00-0452-10
Adapter, Straight Tee ET (box of 12)	0683-00-0242-22
Adapter, Mask Elbow ET (box of 12)	0683-00-0242-12
DRYLINE™ Neonate Sample Line, Patient, (8') (box of 25)	0683-00-0524-25
DRYLINE™ Adult/Pediatric Sample Line, Patient, (8') (box of 25)	0683-00-0525-25
DRYLINE™ Neonate Water Trap Assembly (box of 10)	0202-00-0181-10
DRYLINE™ Adult/Pediatric Water Trap Assembly (box of 10)	0202-00-0182-10
Gas Scavenging Adapter Assembly, Quick Connect*	0997-00-0923

\* For U.S. use only.

DESCRIPTION	PART NUMBERS
Gas Scavenging Adapter Assembly, Luer*	0997-00-0984
Passport 2/Gas Module Mounting Kit	0040-00-0287-03
Wall Mount	0436-00-0061-01

\* For U.S. use only.

## 5.1.5 Reusable Temperature Probes

### YSI 400

DESCRIPTION	PART NUMBER
Adult Rectal / Esophageal	0206-02-0001
Pediatric Rectal / Esophageal	0206-02-0002
Skin Surface	0206-02-0003

### YSI 700

DESCRIPTION	PART NUMBER
Adult Rectal / Esophageal	0206-00-0701
Skin Surface	0206-00-0709

## 5.1.6 Disposable Temperature Probes

### 400 Series Probes (boxes of 20)

DESCRIPTION	PART NUMBER
Esophageal Stethoscope, 12 Fr, ES 400-12	0206-03-0112-02
Esophageal Stethoscope, 18 Fr, ES 400-18	0206-03-0118-02
Esophageal/Rectal, 9 Fr, ER 400-9	0206-03-0209-02
Esophageal/Rectal, 12 Fr, ER 400-12	0206-03-0212-02
Skin, SK 400	0206-03-0300-02
Instrument Cable, 400 Series	0012-00-0975

## 5.1.7 ECG Accessories

### 5.1.7.1 ECG Cables

#### 3/5 Lead ECG Cables

DESCRIPTION	PART NUMBER
10' Straight	0012-00-1255-01
20' Straight	0012-00-1255-02
10' Right Angle	0012-00-1255-03
20' Right Angle	0012-00-1255-04
10' Straight, ESIS	0012-00-1255-05
20' Straight, ESIS	0012-00-1255-06
10' Right Angle, ESIS	0012-00-1255-07
20' Right Angle, ESIS	0012-00-1255-08
10' Neonate Cable, AAMI	0012-00-1265-01

#### Panorama Mobility Cable (ESIS and Non ESIS)

DESCRIPTION	PART NUMBER
Non-ESIS, 10' (3.1 m), AAMI	0012-00-1502-01
Non-ESIS, 20' (6.1 m), AAMI	0012-00-1502-02
ESIS, 10' (3.1 m), AAMI	0012-00-1502-03
ESIS, 20' (6.1 m), AAMI	0012-00-1502-04

### 5.1.7.2 ECG Leadwires

#### ECG Leadwires - 3 Lead

DESCRIPTION	PART NUMBER
3 Lead, Snap 18" (45.7 cm), AAMI	0012-00-1261-07
3 Lead, Snap 24" (61.0 cm), AAMI	0012-00-1261-08
3 Lead, Snap 40" (101.6 cm), AAMI	0012-00-1261-09
3 Lead, Pinch Clip 18" (45.7 cm), AAMI	0012-00-1262-07
3 Lead, Pinch Clip 24" (61.0 cm), AAMI	0012-00-1262-08
3 Lead, Pinch Clip 40" (101.6 cm), AAMI	0012-00-1262-09

#### ECG Leadwires - 5 Lead

DESCRIPTION	PART NUMBER
5 Lead, Snap 18" (45.7 cm), AAMI	0012-00-1261-01
5 Lead, Snap 24" (61.0 cm), AAMI	0012-00-1261-02
5 Lead, Snap 40" (101.6 cm), AAMI	0012-00-1261-03
Snap, Extended Leg, 3/40" (3/101.6 cm), 2/60" (2/152.4 cm), AAMI	0012-00-1261-13
5 Lead, Pinch Clip 18" (45.7 cm), AAMI	0012-00-1262-01
5 Lead, Pinch Clip 24" (61.0 cm), AAMI	0012-00-1262-02

## ECG Leadwires - 5 Lead (Continued)

DESCRIPTION	PART NUMBER
5 Lead, Pinch Clip 40" (101.6 cm), AAMI	0012-00-1262-03
Pinch, Extended Leg, 3/40" (3/101.6 cm), 2/60" (2/152.4 cm), AAMI	0012-00-1262-13

## ECG Leadwires - 12 Lead

DESCRIPTION	PART NUMBER
12 Lead, AAMI	0012-00-1411-02
12 Long Lead, AAMI, 63"	0012-00-1588

## Panorama Mobility Lead Wires

DESCRIPTION	PART NUMBERS
5 Lead, Snap 24" (61.0 cm), AAMI	0012-00-1503-02
3 Lead, Snap 24" (61.0 cm), AAMI	0012-00-1503-05

### 5.1.7.3 12 Lead ECG Accessories

DESCRIPTION	PART NUMBER
View 12 Kit for version 8.2 & higher Panorama/Passport 2 Customers and standalone Passport 2 Customers	VIEW12DOMP2SP
View 12 Kit for version 8.1.6 Panorama Hardwire/Passport 2 Customers	VIEW12DOM8.1.6P2

### 5.1.7.4 Electrodes

DESCRIPTION	PART NUMBER
Neo Pre-wired (3 Lead Combiner Clip) 18", AAMI, box of 100 Pks of 3 Ea: Radio Opaque Set	0681-00-0098-01
Neo Pre-wired (3 Lead Combiner Clip) 18", AAMI, box of 100 Pks of 3 Ea: Radio Translucent Set	0681-00-0098-02
Disposable pre-gelled ECG Electrodes, foam base and Hydrogel conductive adhesive, 1 case of 600/10 boxes of 60	0681-00-0100-01
Disposable pre-gelled ECG Electrodes, foam base and Hydrogel conductive adhesive, 1 case of 60	0681-00-0100-02

### 5.1.8 IBP Accessories

#### IBP

DESCRIPTION	PART NUMBER
P10EZ Miniature (Reusable)	0682-00-0085
P23XL-1 Transducer (Reusable)	0682-00-0084
Cable, Interface, Transducer	0012-00-1245

## 5.1.9 Comm-Port Accessories

### Comm-Port

DESCRIPTION	FUNCTION	PART NUMBER
Comm-Port 2	CS1, MB1, RD1	0998-00-0178-03
Comm-Port 3	RD1, NC1, SP1	0998-00-0178-05
Comm-Port 4	CS1, MB1, SP1	0998-00-0178-04
Comm-Port 5	SP1, NC1, SP2	0998-00-0178-06

*CS = Ethernet Port, MB = Module Bus, SP = Serial Port, RD = Remote Display, NC = Nurse Call*

### Nurse Call (NC1)

DESCRIPTION	PART NUMBER
Unterminated Cable, 9'	0012-00-1277-02

### Serial Port (SP1)

DESCRIPTION	PART NUMBER
Cable, Serial Port to Gas Module, 12" (30.48 cm)	0012-00-1276-01
Cable, Serial Port to Gas Module, 72" (182.88 cm)	0012-00-1276-02
Cable, Interface, PC, Serial Port to Serial Port	0012-00-1275-01
Cable, Serial Port to VISA, 10' (3.05 m)	0012-00-1299-01

### Ethernet (CS1)

DESCRIPTION	PART NUMBER
CAT 5 Ethernet Cable, Patch, STP, 6' (1.83 m)	0012-00-1274-01
CAT 5 Ethernet Cable, Patch, STP, 25' (7.62 m)	0012-00-1274-02
CAT 5 Ethernet Cable, Patch, STP, 50' (15.24 m)	0012-00-1274-03
CAT 5 Ethernet Cable, Patch, STP, 1' (0.30 m)	0012-00-1274-04
CAT 5 Ethernet Cable, Patch, STP, 2' (0.61 m)	0012-00-1274-05
CAT 5 Ethernet Cable, Patch, STP, 3' (0.91 m)	0012-00-1274-06
CAT 5 Ethernet Cable, Patch, STP, 10' (3.05 m)	0012-00-1274-07
Laser Printer, Laserjet 4200N	0992-00-0091-04
Paper, Laser Printer, View 12	0683-00-0503
ECS, HUB, 12 Port	0992-00-0085-01
CAT 5 Ethernet Cable, Crossover, STP, 3' (0.91 m)	0012-00-1392-05
CAT 5 Ethernet Cable, Crossover, STP, 6' (1.83 m)	0012-00-1392-06
CAT 5 Ethernet Cable, Crossover, STP, 10' (3.05 m)	0012-00-1392-07
CAT 5 Ethernet Cable, Crossover, STP, 20' (6.10 m)	0012-00-1392-08



### 5.1.10 Base Station Accessories

DESCRIPTION	PART NUMBERS
Base Station kit with 110V line cord	BASESTATION110
Base Station 110V line cord	0012-25-0001
Base Station power supply	0014-00-0070
Base Station mounting kit	0386-00-0259
Base Station Operator's manual multilanguage	0073-00-1292

### 5.1.11 Miscellaneous Accessories

DESCRIPTION	PART NUMBER
Recorder Chart Paper (10 Rolls)	0683-00-0422-02
Battery, Lithium-Ion	0146-00-0069
Battery, Sealed Lead Acid	0146-00-0043
AC Power Cord, 120V	0012-25-0001
Cable Assy, DPD Defibrillator, 8" (20.32 cm)	0012-00-1301-01
Cable Assy, DPD Defibrillator, 10' (3.05 m)	0012-00-1301-02
Cable Assy, Analog Output (ECG only), 15' (4.57 m)	CABLEANALOGOUT
Cable, ECG/IBP to IABP interface, for Software Version AC.07 and above, 6-pin (4.6 m)	0012-00-1650-01
Transfer Card	0996-00-0051-01
Extended Trend Card	0996-00-0052-01
Abbreviated Operator's Manual	0070-00-0493
12 Lead ECG Physician's Reference Guide, English Version	0070-00-0524-01

### 5.1.12 Mounting Kits and Accessories

DESCRIPTION	PART NUMBER
Rolling Stand with mounting bracket	TRANSLBRKT
Rolling Stand with quick release plate	TRANSQRMTG
Wall Mount Kit	0040-00-0287-02
VHM Wall Mount	0040-00-0287-04
Bedrail Mount Kit	0040-00-0293
Quick Release Mounting Plate Kit	0040-00-0299-01
Stationary Mounting Bracket Kit	0040-00-0299-02
Gas Module Mounting Kit	0040-00-0287-03
12 Lead ECG Mounting Kit	0040-00-0311-01

### 5.1.13 Upgrade Kits

DESCRIPTION	PART NUMBER
CO <sub>2</sub> Upgrade Kit with Masimo SpO <sub>2</sub>	0040-00-0353-01
CO <sub>2</sub> Upgrade Kit with Nellcor® Oxismart® SpO <sub>2</sub>	0040-00-0353-02
CO <sub>2</sub> Upgrade Kit with Nellcor® OxiMax® SpO <sub>2</sub> , Nell-3	0040-00-0353-03
CO <sub>2</sub> MiniMedi Upgrade - For use in units with serial number prefix TS only, with Masimo SpO <sub>2</sub> (includes installation at Mindray DS Repair Center)	0040-00-0353-04
CO <sub>2</sub> MiniMedi Upgrade - For use in units with serial number prefix TS-XXXX-A6 and below only, with Nellcor OxiSmart SpO <sub>2</sub> (includes installation at Mindray DS Repair Center)	0040-00-0353-05
CO <sub>2</sub> MiniMedi Upgrade - For use in units with serial number prefix TS-XXXX-B6 and above only, with Nellcor OxiMax SpO <sub>2</sub> (includes installation at Mindray DS Repair Center)	0040-00-0353-06
IBP Upgrade Kit (Add IBP1 and IBP2)	0040-00-0268-01
AR42 Recorder Upgrade Kit (serial number tailcode - F3 or lower)	0040-00-0267-01
Xena Recorder Upgrade Kit (serial number tailcode - G3 or higher)	0040-00-0267-02
ST Software Option Enable Kit - 1 License	0040-00-0300-01
ST Software Option Enable Kit - 5 Licenses	0040-00-0300-02
ST Software Option Enable Kit - 10 Licenses	0040-00-0300-03
Arrhythmia Software Option Enable Kit - 1 License	0040-00-0300-11
Arrhythmia Software Option Enable Kit - 5 Licenses	0040-00-0300-12
Arrhythmia Software Option Enable Kit - 10 Licenses	0040-00-0300-13
ST & Arrhythmia Software Option Enable Kit - 1 License	0040-00-0300-21
ST & Arrhythmia Software Option Enable Kit - 5 Licenses	0040-00-0300-22
ST & Arrhythmia Software Option Enable Kit - 10 Licenses	0040-00-0300-23

### 5.1.14 Central Station Accessories

DESCRIPTION	PART NUMBER
Transmitter Mounting Kit	0040-00-0296
Kit, Telemetry, 2.4 GHz	0040-00-0327-XX
Kit, Mounting, Transmitter, DT-7000, PatientNet	0020-00-0458-01
Kit, Instrument Radio, Panorama, 608 MHz	0040-00-0361-01

**This page intentionally left blank.**

---

## 6.1 Safety Designations

### 6.1.1 Safety designations per IEC 60601-1 Standard

Type of protection against electrical shock:	Class 1 and Internal Electric Power Source. Where the integrity of the external protective earth in the installation or its conductor arrangement is in doubt, equipment shall be operated from its internal electric power source.
Degree of protection against electric shock:	ECG and IBP, Type CF defibrillation protected. NIBP, Type BF defibrillation protected. SpO <sub>2</sub> , CO <sub>2</sub> , and Temperature, Type BF
Supply Connection:	100V - 240VAC 50 or 60 Hz. 1.2 - 0.7 A 12 VDC Sealed Lead Acid Internal Battery or 11.1 VDC Lithium-Ion Internal Battery
Mode of Operation:	Continuous
Protection Against Hazards of Explosion:	Not Protected (Ordinary)
Protection Against Ingress of Liquids:	Not Protected (Ordinary)

Degree of Electrical Connection between Equipment and Patient: Equipment designed for direct electrical and non-electrical connection to the patient

Degree of Mobility: Transportable, Intra-Hospital

## 6.2 Performance Specifications

### 6.2.1 ECG

The 3/5 Lead ECG function is in accordance with the requirements of EN 60601-2-27.

The 12 Lead ECG function is in accordance with the requirements of EN 60601-2-25.

#### 6.2.1.1 ECG Performance Requirements

##### Leads

Three Lead Displayable Leads:	I, II, III
Five Lead Displayable Leads:	I, II, III, aVR, aVL, aVF, V (n)
Twelve Lead Displayable Leads:	I, II, III, aVR, aVL, aVF, V1, V2, V3, V4, V5, V6
3 Lead and 5 Lead Connector Types:	Standard AAMI six pin or HP cable compatible.
12 Lead Connector Type:	Type II PCMCIA card with integrated processor electronics and cable assembly.
3 Lead or 5 Lead Cable Detection:	Automatic detection of three wire or five wire, with Mindray DS auto-detecting cables.
12 Lead Card Enabling:	12 Lead processing and analysis will be enabled and disabled through button toggling, located in the Function menu.
Defibrillator Overload Protection:	No damage from 360 Joule discharge. Meets all requirements of IEC 60601-2-27, 51.101.1
AC Overload Protection:	Withstands 60 Hz, 1V p-p for 10 seconds (ANSI/AAMI EC13-1992, 3.2.2.1 or ANSI/AAMI EC 11-1991, 3.2.14.1)
Recovery:	Recovers from defibrillator overload or lead fault to within 1mV, referred to input, in < 8 seconds automatically. (< 5 seconds 12 Lead ECG). Recovers from a 1 V p-p 60 Hz overload within 3 seconds.

---

ESU Protection:	3 Lead and 5 Lead ECG shall meets standard IEC 601-2-25, clause 36.202.7 for functionality following ESU energy exposure. The 12 Lead ECG function provides no ESU protection.
Electro Surgical Unit	Noise Suppression: Peak noise is less than $\pm 2$ mV from ECG baseline when used with AAMI compatible cables. Noise level is unspecified when the monitor is used with HP cables. The 12 Lead ECG function provides no ESU protection or noise suppression.
ESU Withstand:	3 Lead and 5 Lead ECG shall withstand ESU stress from a High Frequency Surgical Units operating at 300 Watts in cut mode and 100 Watts on coagulate mode. The 12 Lead ECG function provides no ESU protection.
Input Bias Current:	< 100 nA per lead, excluding driven lead (ANSI/AAMI EC13-1992, 3.2.5 or ANSI/AAMI EC 11-1991 3.2.10).
Input Signal Range:	$\pm 5.0$ mV, minimum
DC Offset:	$\pm 300$ mV minimum (ANSI/AAMI EC13-1992, 3.2.9.1 or ANSI/AAMI EC 11-1991, 3.2.3).
Input Impedance:	> 2.5 M $\Omega$ single ended at 10Hz per ANSI/AAMI EC13-1992, 3.2.9.2 or ANSI/AAMI EC11-1991, 3.2.9.
Noise:	Less than 30 $\mu$ V p-p, referred to input, through shielded 51K $\Omega$ resistors in parallel with 47nF capacitors (ANSI/AAMI EC13-1992, 3.2.9.3 or ANSI/AAMI EC 11-1991, 3.2.12.1).
Overall System Error:	5% or 40 $\mu$ V, whichever is greater (ANSI/AAMI EC-13-1992, 3.2.9.8 or ANSI/AAMI EC 11-1991, 3.2.7.1)
Gain Stability:	Per ANSI/AAMI EC13-1992, 3.2.9.5 (d) or ANSI/AAMI EC 11-1991, 3.2.4.4.

Multichannel Crosstalk:	Maximum of 2%, per ANSI/AAMI EC13-1992, 3.2.12.2 or ANSI/AAMI EEC) 11-1991, 3.2.12.2.
3 Lead and 5 Lead Drift Rate:	10 $\mu\text{V/s}$ maximum, referred to input, with all leads shorted through 25K $\Omega$ resistors. Total drift shall be less than 500 $\mu\text{V}$ over a 1 hour period per ANSI/AAMI EC 13-1992, 3.2.9.11.
12 Lead Drift Rate:	10 $\mu\text{V/s}$ maximum, referred to input with all leads shorted through 25K $\Omega$ resistors. Total drift shall be less than 500 $\mu\text{V}$ over a 2 minute period per ANSI/AAMI EC 11-1991, 3.2.13.2.

### Frequency & Impulse Response 3 Lead and 5 Lead configuration

AAMI:	0.5 to 40 Hz (-3dB) in the Monitor mode, 0.05 to 100 Hz in the extended mode and 0.05 to 40 Hz in the ST Mode. Meets the Extended low frequency response and impulse response requirements (with the ESU filter disabled) of ANSI/AAMI EC13-1992, 3.2.9.8 (c).
HP:	0.55 to 35 Hz (-3dB) in the Monitor mode, 0.005 to 90 Hz in the extended mode and 0.005 to 35 Hz in the ST Mode. Meets the Extended band width and impulse response requirements (with the ESU filter disabled) of ANSI/AAMI EC13-1992, 3.2.9.8 (c).
Frequency & Impulse Response 12 Lead configuration:	Meets the frequency response and impulse response requirements of ANSI/AAMI EC11-1991, 3.2.7.2, A and D (0.67 to 40 Hz sinusoidal and -10% for 20 msec triangle).
Notch Filter Selections:	Off, 50 Hz, or 60 Hz.



CMRR:	90 dB min., Maximum, output of 1mV p-p (RTI) over a 60 second period at 50/60 Hz, with a parallel combination 51K $\Omega$ and 0.047 $\mu$ F imbalance and $\pm$ 300 mV DC offset per AAMI EC13-1992 3.2.9.10 or ANSI/AAMI EC 11-1991,3.2.11.
Lead Fault:	Lead resistance $\leq$ 51K $\Omega$ in parallel with 0.047 $\mu$ F shall not cause a lead fault condition. Also, a $\pm$ 300 mV offset shall not cause a lead fault condition.
Pacer Enhancement:	Pacer signals with amplitudes within the range $\pm$ 2mV and $\pm$ 700 mV (RTI) amplitude with a maximum rise time of 100usec and with duration in the 0.1ms to 2.0ms range shall be enhanced when the Pacer Mode is turned ON.
ESIS Filtering: (3 Lead and 5 Lead ECG configuration):	Greater than 90 dB attenuation at 500 kHz.
ESU Noise Detection:	An ESU noise declaration will be asserted if signals detected as pacers are detected at a rate greater than 50 Hz. No noise declaration will be asserted if pacer-like signals are detected at a rate less than 10 Hz. Applies to 3 Lead and 5 Lead ECG configurations only.

## 6.2.2 Analog Output Specifications

### 6.2.2.1 3 Lead and 5 Lead ECG

Propagation Delay (Delay of QRS complex):	25 ms maximum.
Sensitivity (referenced to 10Hz):	1 V/mV of input, $\pm$ 10%.
Pacer Enhancement:	Pacer is summed at the output when pacer enhance mode is turned ON. Pacer Amplitude signal is a minimum of 2.5V Pacer width is 10 ms, with a 5% tolerance. Pacer rise and fall times are 100 ms, maximum.

### 6.2.2.2 Arterial Blood Pressure

(Only in monitors with serial number prefix "TS" and software versions AC.X and higher.)

Bandwidth (-3 dB referenced to 10 Hz): DC to 15 Hz minimum.

Propagation Delay: 25 ms, maximum.

Sensitivity: 1 V/100 mmHg,  $\pm$  10%.

### 6.2.2.3 Sync Pulse for Cardioversion

Propagation Delay: 35 ms maximum, between QRS peak and the rising edge of the Sync Pulse.

Amplitude: 2 V min.

Width: 7 ms (3 Lead and 5 Lead ECG) 11 ms (12 Lead ECG)

Source: The Sync Pulse is derived from the active ECG source.

**CAUTION:** The Analog Output on the Passport 2/Passport 2 LT supports triggering the Intra-Aortic Balloon Pump (IABP) for 3 Lead and 5 Lead ECG cable monitoring only. Invasive Blood Pressure triggering is not supported. ECG analog output is disabled when 12 Lead ECG analysis is enabled.

**CAUTION:** To assure successful triggering of Intra-Aortic balloon pump from the Passport 2/Passport 2 LT monitor, set the "ECG Filter" to "Extended" and set "Pacer Enhancement" to "On". Both of these settings are located in the ECG setup menu of the Passport 2/Passport 2 LT.

## 6.2.3 Systole Detector and Heart Rate Meter

The heart rate (HR) meter data source is automatically selected from the available monitored parameters. The selection priority is: (1) ECG; (2) IBP1; (3) IBP2; (4) SpO<sub>2</sub>; (5) NIBP

### 6.2.3.1 ECG Derived Heart Rate Meter Performance Requirements

Range: 30 to 300 bpm Adult / Pediatric  
30 to 350 bpm Neonatal  
(3-Lead or 5-Lead ECG)  
30 to 300 bpm Neonatal (12-Lead ECG)

Resolution: 1 bpm.

---

Accuracy:	$\pm 3$ bpm or $\pm 3\%$ at 30 to 250 bpm, whichever is greater. $\pm 5\%$ 251 to 350 bpm.
Alarm Response Time:	< 10 seconds for 60 bpm low limit alarm to sound when stepping from heart rate of 80 to 0 bpm and 80 to 40 bpm (ANSI/AAMI EC13-1992, 3.2.8.4 and 5). < 10 seconds for 100 bpm high limit alarm to sound when stepping from a heart rate of 80 to 120 bpm (ANSI/AAMI EC13-1992, 3.2.8.6).
Trigger Threshold:	Does not trigger on signals less than 0.15 mV in amplitude or less than 10m seconds wide (ANSI/AAMI EC13-1992, 3.2.6.1) in ADULT mode.
Detectable QRS Width:	70 to 120 ms, minimum, for Adults. 40 to 120 ms, minimum, for Pediatric and Neonate patients (ANSI/AAMI EC13-1992, 3.2.6.1)
60 Hz Voltage Tolerance:	Tolerates 60 Hz sinusoidal voltage less than or equal to 0.1 mV p-p RTI per ANSI/AAMI EC13-1992, 3.2.6.2.
Drift Tolerance:	Tolerates triangular wave of 0.1 Hz, 4 mV p-p RTI superimposed on the ECG per ANSI/AAMI EC13-1992, 3.2.6.3.
Tall T-Wave Rejection:	Rejects T-waves less than 120% of 1mV QRS, and Q-T interval of 350 ms per AAMI EC13-1992, 3.1.2.1 (c).

Pacemaker Pulse Rejection:	Rejects pulses of amplitude $\pm 2.0$ mV to $\pm 700$ mV and duration 0.1 ms to 2 ms with no tail (ANSI/AAMI EC13-1992, 3.1.4.1).
	3/5 Lead ECG: Rejects all pacer pulses $\pm 2.0$ mV to $\pm 700$ mV and duration 0.1 ms to 2 ms with 4 ms time constant tail of less than 2.0 mV.
	12 Lead ECG: Does not reject pacer pulses with tails (overshoot/undershoot).
Trigger Indication:	Audible beep on every beat captured.
Heart Rate Averaging:	3/5/12 Lead ECG: The average heart rate is calculated as follows: Mean R to R interval in the last 16 R to R intervals (HR > 48 bpm). Mean R to R interval in the last 4 R to R intervals (HR $\leq$ 48 bpm).

### 6.2.3.2 IBP Derived Heart Rate Meter Performance

Refer to Section 6.2.8.4

### 6.2.3.3 SpO<sub>2</sub> Derived Heart Rate Meter Performance

Refer to Section 6.2.11.2 and 6.2.11.4

### 6.2.3.4 NIBP Derived Heart Rate Meter

Refer to Section 6.2.6.2

## 6.2.4 S-T Segment Analysis

### 6.2.4.1 S-T Segment Analysis Performance Requirements

Enabling:	Available in ADULT and PEDIATRIC modes only.
ST Deviation Range: (3-Lead and 5-Lead ECG)	9.9 mm to + 9.9mm (-990 $\mu$ V to + 990 $\mu$ V RTI)
Resolution:	0.1 mm (10 $\mu$ V)
Default ST Measurement Point:	80 ms after J point for heart rates $\leq$ 120 bpm.

Enabling:	Available in ADULT and PEDIATRIC modes only. 60 ms after the J point for heart rates > 120 bpm.
User Selectable ST Measurement Points:	40, 60 and 80 ms after J point (heart rate independent) or 60/80 Heart Rate Dependent.
Default ISO Point:	Is located between the P and Q waves. Is user adjustable from "R peak" - 10 ms to "R peak" - 200 ms in increments of 12 ms.
Default J Point:	The end of the QRS complex. Is user adjustable from "R peak" + 10 ms to "R peak" + 200 ms in increments of 12 ms.
Excluded beats:	Ectopic beats and paced beats are excluded from ST measurement.
Invalid ST:	During 3 Lead and 5 Lead ECG modes ST data is invalidated when paced rhythm, Ventricular Rhythm, or Ventricular Tachycardia persists for more than 45 seconds, and/or during detected episodes of Asystole and Ventricular Fibrillation. During 12 Lead ECG mode ST data shall be invalidated when the paced rhythm or Ventricular Rhythm persists for more than 30 seconds, and/or during detected episodes of Asystole, Ventricular Fibrillation and Ventricular Tachycardia.

## 6.2.5 Arrhythmia Analysis

- Arrhythmia analysis can be enabled in Adult and Pediatric modes.
- Arrhythmia analysis identifies ventricular arrhythmias only.
- The following arrhythmia calls are made during 3 Lead and 5 Lead mode:  
Asystole, Irregular Heart Rate, Couplet, Bigeminy, Trigeminy, Ventricular Tachycardia, Ventricular Fibrillation, Ventricular Rhythm, PVCs per minute, Run, Bradycardia.
- The following Arrhythmia calls are made during 12 Lead ECG mode:  
Asystole, Pause, Couplets, Runs, Bigeminy, Trigeminy, Ventricular Tachycardia, Ventricular Fibrillation, PVCs per minute, Ventricular Rhythm.

- Optionally, non-lethal or all arrhythmia alarms are capable of being disabled.
- In 3 Lead and 5 Lead ECG modes: PVCs per minute are invalidated and the PVC counter is reset to 0 during periods of Ventricular Rhythm, Ventricular Tachycardia, Ventricular Fibrillation or Asystole.
- In 12 Lead ECG mode: PVCs per minute are invalidated and the PVC counter is reset to 0 during periods of Ventricular Rhythm, Ventricular Tachycardia, and Ventricular Fibrillation. During periods of Asystole, the PVC counter is reset to 0.

### 6.2.5.1 12-Lead ECG Interpretation

The **Passport 2**, equipped with optional 12-Lead ECG, has the ability to make Interpretation, Rhythm and Condition statements in accordance with the *Physician's Guide to Computerized ECG Analysis* (Mindray DS P/N 0070-00-0524-01 English, 0070-00-0524-50 all other languages).

- Interpretive statements are disabled in neonatal and pediatric modes.
- Interpretive statements are disabled in adult mode for ages less than 18 years old.

### 6.2.6 NIBP Sub-System Performance Characteristics

This function calculates the patient blood pressure non-invasively, using a blood pressure cuff. There are three pressure readings available: systolic, diastolic, and mean pressures.

#### Systolic Pressure Measurements

Accuracy <sup>1,2</sup> :	Mean error is less than $\pm 5$ mmHg Standard Deviation shall be less than $\pm 8$ mmHg.
Range:	55 to 235 mmHg in Adult mode 55 to 160 mmHg in Pediatric mode. 45 to 120 mmHg in Neonatal mode.

#### Diastolic Pressure Measurements

Accuracy <sup>1,2</sup> :	Mean error is less than $\pm 5$ mmHg, Standard deviation is less than $\pm 8$ mmHg.
Range:	30 to 200 mmHg in Adult mode 30 to 150 mmHg in Pediatric mode. 20 to 100 mmHg in Neonatal mode.

<sup>1</sup>Adult and Pediatric - Blood pressure measurements determined with this device are equivalent to those obtained by a trained observer using the cuff/stethoscope auscultation method, within the limits prescribed by the American National Standard, *Electronic or automated sphygmomanometers*.

<sup>2</sup>Neonate - Blood pressure measurements determined with this device are equivalent to those obtained by an intraarterial blood pressure measurement device, within the limits prescribed by the American National Standard, *Electronic or automated sphygmomanometers*.

**NOTE:**      **Mean Arterial Pressure (MAP) is defined as:**  
**Mean Pressure 1 = Mean Pressure determined from the oscillometric profile**  
**Mean Pressure 2 = (2\*diastolic + systolic) / 3**  
**Mean Pressure Displayed = (Mean Pressure 1 + Mean Pressure 2) / 2**

### 6.2.6.1 Pressure Measurement System

Connector:	Rectus pneumatic fitting.
Range:	0-300 mmHg.
Static Accuracy:	± 3 mmHg or 2% whichever is greater in the range of 20 to 275 mmHg.

### 6.2.6.2 Pulse Rate

Pulse Rate Range:	35-245 bpm, for Adults/Ped 70– 245 bpm, for Neonate.
Pulse Rate Resolution:	1 bpm
Pulse Rate Accuracy:	± 3 bpm or ± 3%, whichever is greater.

### 6.2.6.3 Maximum Cuff Pressure

Software Over Pressure Limits:	Adult: ≤300 mmHg Pediatric: ≤200 mmHg Neonate: ≤150 mmHg
Hardware Over Pressure Limits:	Adult: ≤330 mmHg Pediatric: ≤220 mmHg Neonate: ≤65 mmHg

### 6.2.6.4 Cuff Inflation

The inflation source is capable of supplying sufficient air to bring a volume of 500 cc's to a pressure of 300 mmHg in no more than 35 seconds (reference ANSI/AAMI SP10A-1996).

If the cuff is not inflated to the desired pressure within 60 seconds then the cuff is vented and a retry cycle is initiated up to 3 times.

### 6.2.6.5 Maximum Leakage

The maximum allowed pressure drop with the bleed valves closed is 10 mmHg in 10 seconds as measured with a 500 cc volume at differential pressures of 250 mmHg, 150 mmHg and 50 mmHg (reference ANSI/AAMI SP10-1992, EN1060-3, 1997).

### 6.2.6.6 Vent Rate

A volume of 500 cc, when vented, is reduced from a pressure of 260 mmHg to a pressure of 15 mmHg in a maximum of 10 seconds. For Neonate, from a pressure of 150 mmHg to a pressure of 5 mmHg in less than 5 seconds (reference: EN1060-3, 1997).

## 6.2.7 NIBP Sub-System Functional Requirements

### 6.2.7.1 Initial Conditions

The NIBP System performs a zero calibration adjustment at power-up.

### 6.2.7.2 NIBP Starting Pressure Settings and Ranges

Range of Adjustment:	Adult Patients, 100-280 mmHg Pediatric Patients, 60-180 mmHg Neonatal Patients, 40-120 mmHg
----------------------	---

Default Start Pressure:	Adult Patients, 180 mmHg. Pediatric Patients, 140 mmHg. Neonatal Patients, 100 mmHg.
-------------------------	--

Pressure Increment:	5 mmHg, regardless of patient size.
---------------------	-------------------------------------

### 6.2.7.3 NIBP Measurement Cycle

There are two different modes of measurement operation: manual and interval modes. The manual mode requires the operator to initiate the measurement cycle. The interval mode follows a configured plan of automatically initiated measurement cycles.

The Maximum Measurement Cycle Duration shall be 180 sec for Adult and Pediatric patients (reference EN601-2-30, 1995).

The Maximum Measurement Cycle Duration shall be 90 sec for Neonatal patients (reference EN601-2-30, 1995).

During a measurement, if the initial cuff inflation pressure is found to be inadequate, the unit shall retry with a higher inflation pressure (+50 ±10 mmHg in Adult and Pediatric modes and +40 ±10 mmHg in Neonatal mode).

In interval mode only, the unit shall adjust the inflation pressure according to the previous systolic pressure. After the first successful measurement is made, the subsequent inflation pressure becomes +50 ±10 mmHg in the Adult and Pediatric modes and +40 ±10 mmHg in Neonatal mode.



## 6.2.8 IBP Parameter Sub-System Performance Characteristics

The IBP function is in accordance with the requirements of EN 60601-2-34.

### 6.2.8.1 IBP Performance Requirements

Accuracy:  $\pm 2$  mmHg or 2% which ever is greater (excluding transducer error).

### 6.2.8.2 IBP Connector Type

AAMI standard six pin.

Configurations of the patient monitor which include IBP have two (2) identical IBP connectors. Either or both may be used at a given time.

### 6.2.8.3 IBP Transducer Performance

Excitation: 5 Volts DC,  $\pm 2\%$  Minimum load resistance shall be 300 ohms per transducer.

Transfer Function: Compatible with 5uV/mmHg/Volt excitation nominal transducers.

Zero Offset Range:  $\pm 120$  mmHg

Zero Accuracy:  $\pm 1$  mmHg

Linear Input Range: -30 to +300 mmHg, after zeroing.

Noise:  $< 0.5$  mmHg RTI, DC to 15 Hz, 300 W source impedance

Drift:  $< 0.15$  mmHg / °C.

Frequency Response: DC to 16 Hz  $\pm 1$  Hz, -3db

### 6.2.8.4 IBP Heart Rate Meter

Range: 30 to 300 bpm Adult / Pediatric 30 to 350 bpm Neonatal

Resolution: 1 bpm

Accuracy:  $\pm 3$  bpm or  $\pm 3\%$  at 30 to 250 bpm

Trigger Threshold: 18mm  $\pm$  9mmHg

Step Change Response Time:	less than 10 sec, 80 to 120 bpm Adult/ Pediatric/Neonatal
	less than 11 sec, 80 to 40 bpm Adult/ Pediatric/Neonatal

## 6.2.9 Temperature Parameter Performance Characteristics

### 6.2.9.1 Connector Type

The temperature parameter sensor cable connects with a 3 circuit 0.25 inch phonejack as a standard feature.

YSI 400:

Tip:	Thermistor
Ring:	Short to Sleeve
Sleeve:	Common/Ground

YSI 700:

Tip:	Thermistor 1
Ring:	Thermistor 2
Sleeve:	Common/Ground

### 6.2.9.2 Temperature Performance Requirements

Scale:	Selectable °C or °F
Range:	15°C to 45°C, 59°F to 113°F
Resolution:	0.1°C / 0.1°F
Accuracy:	± 0.1°C (15°C - 45°C), exclusive of probe errors ± 0.2°F (59°F - 113°F), exclusive of probe errors
Inclusive Accuracy, 400 Series Probes:	± 0.1°C (25°C - 42°C), ± 0.2°C (otherwise) ± 0.2°F (77°F - 108°F), ± 0.4°F (otherwise)
Inclusive Accuracy, 700 Series Probes:	± 0.2°C (25°C - 42°C), ± 0.4°F (77°F - 108°F)
Probe Excitation - 400 Series	< 200 µA, Tip to Sleeve

Scale:	Selectable °C or °F
Probe Excitation - 700 Series	< 200 $\mu$ A, Tip to Sleeve and < 30 $\mu$ A maximum, Ring to Sleeve

## 6.2.10 Respiration

### 6.2.10.1 ECG Respiration Performance Requirements

Leads:	Primary lead shall be II. User selectable to lead I.
Source:	When 12 Lead ECG is enabled, the <b>Passport 2</b> is capable of acquiring respiration while using a 3 Lead or 5 Lead ECG cable.
Range:	4 to 199 breaths per minute
Accuracy:	$\pm 2\%$ or $\pm 2$ breaths per minute, whichever is greater from 4 to 150. $\pm 4\%$ , from 151 to 199.
Excitation:	$\leq 550 \mu$ A RMS max.
Bandwidth:	0.1 Hz to 3 Hz (-3 dB) for Adults. 0.2 Hz to 3 Hz (-3 dB) for Pediatric and Neonatal patients
Baseline Impedance Range:	200 $\Omega$ to 2000 $\Omega$ at patient with 1k resistor in the ECG cable.
High Impedance Indication:	>2.2 k $\Omega$ at patient
Resp Scale:	1, 2, 3, 4, or 5 with standard ECG cable.
Linear Signal Range:	8W p-p minimum.
Noise:	< 0.05 $\Omega$ at 500 $\Omega$ patient impedance, using a standard ECG cable.
Min. Breath Height Detected:	Is a function of respiration scale. Waveform needs to be greater than 0.1 $\Omega$ in order for breathes to be accurately detected.
Cardiovascular Artifact Rejection:	Will be detected by algorithm.

## 6.2.10.2 CO<sub>2</sub> Respiration Performance Requirements

### MediCO<sub>2</sub> Microstream<sup>®</sup> (Only in monitors with serial numbers below TS10000.)

Respiration Rate Range:	0 - 150 RPM.
Respiration Rate Accuracy:	$\pm 1$ RPM from 0 to 40 RPM $\pm 2$ RPM from 41 to 70 RPM $\pm 3$ RPM from 71 to 100 RPM $\pm 5$ RPM from 101 to 150 RPM

### MiniMediCO<sub>2</sub> Microstream<sup>®</sup> (Only in monitors with serial number TS10000 and higher.)

Respiration Rate Range:	0 - 150 RPM.
Respiration Rate Accuracy:	$\pm 1$ RPM from 0 to 70 RPM $\pm 2$ RPM from 71 to 120 RPM $\pm 3$ RPM from 121 to 150 RPM

## 6.2.11 SpO<sub>2</sub>

- SpO<sub>2</sub> is a non-invasive measurement of the functional oxygen saturation.
- The SPO<sub>2</sub> function is in accordance with the requirements of EN 865.

### 6.2.11.1 Masimo<sup>®</sup> SpO<sub>2</sub> Performance Requirements

Sensor Compatibility:	
Masimo:	LNOP <sup>®</sup> Series.
Connector Type:	14-lead "Mini D-Ribbon" Receptacle (Masimo PC-12).
Measurement Technique:	
Masimo Sensors:	Masimo proprietary algorithm (SET).
SpO <sub>2</sub> Accuracy Saturation during No Motion Conditions <sup>1</sup> :	
Adults / Pediatrics:	70% to 100% $\pm 2^5$ , 0 to 69% unspecified.
Neonates:	70% to 100% $\pm 3$ , 0% to 69% unspecified.
SpO <sub>2</sub> Accuracy Saturation during Motion Conditions <sup>6</sup> :	
Adults / Pediatrics <sup>2</sup> :	70% to 100% $\pm 3$ , 0 to 69% unspecified.

Sensor Compatibility:	
Neonates <sup>3</sup> :	70% to 100% $\pm$ 3, 0% to 69% unspecified.
SpO <sub>2</sub> Response Time:	18 seconds to 95% of final step change of % SpO <sub>2</sub> value from 60 to 95% at 75bpm.

**NOTE: This time was measured with post average time set at 8 seconds.**

Low Perfusion Performance <sup>4</sup> :	>0.02% Pulse Amplitude and % Transmission >5%. Saturation (%SpO <sub>2</sub> ) $\pm$ 2 digits, Pulse $\pm$ 3 digits.
Wavelengths Emitted:	660 nm and 905 nm.
Maximum Emitted Energy:	30 mW at 50 mA pulsed.
Interfering Substances:	Carboxyhemoglobin may erroneously increase readings. The level of increase is approximately equal to the amount of carboxyhemoglobin present. Dyes, or any substance containing dyes, that change usual arterial pigmentation may cause erroneous readings.

## 6.2.11.2 Masimo<sup>®</sup> Pulse Rate Performance

Pulse Rate During No Motion Conditions<sup>4</sup>:

Adult/Pediatric/Neonates: 30 to 235 bpm  $\pm$  3 digits

Pulse Rate During Motion Conditions<sup>2,3</sup>:

Adult/Pediatric/Neonates: 30 to 235 bpm  $\pm$  5 digits

Update Rate: Every 2 seconds

<sup>1</sup>The Masimo MS-3 pulse oximeter with LNOP<sup>®</sup>•Adt sensors have been validated for no motion accuracy in human blood studies on healthy adult volunteers in induced hypoxia studies in the range of 70% to 100% SpO<sub>2</sub> against a laboratory co-oximeter and ECG monitor. This variation equals plus or minus one standard deviation. Plus or minus one standard deviation encompasses 68% of the population.

<sup>2</sup>The Masimo MS-3 pulse oximeter with LNOP<sup>®</sup>•Adt sensors has been validated for motion accuracy in human blood studies on healthy adult volunteers in induced hypoxia studies while performing rubbing and tapping motions at 2 to 4 Hz. At an amplitude of 1 to 2 cm and non-repetitive motion between 1 to 5 Hz. At an amplitude of 2 to 3 cm in induced hypoxia studies in the range of 70% to 100% SpO<sub>2</sub> against a laboratory co-oximeter and ECG monitor. This variation equals plus or minus one standard deviation. Plus or minus one standard deviation encompasses 68% of the population.

<sup>3</sup>The Masimo MS-3 pulse oximeter with LNOP<sup>®</sup>•Neo and LNOP<sup>®</sup>•NeoPt sensors has been validated for motion accuracy in human blood studies on neonates while moving the neonates foot at 2 to 4 Hz at an amplitude of 1 to 2 cm against a laboratory co-oximeter and ECG monitor. This variation equals plus or minus one standard deviation. Plus or minus one standard deviation encompasses 68% of the population.

<sup>4</sup>The Masimo MS-3 pulse oximeter has been validated for low perfusion accuracy in bench top testing against a Biotek Index 2 simulator and Masimo's simulator with signal strengths of greater than 0.02% and a % transmission of greater than 5% for saturation's ranging from 70% to 100%. This variation equals plus or minus one standard deviation. Plus or minus one standard deviation encompasses 68% of the population.

<sup>5</sup>The LNOP<sup>®</sup>•Ear Sensors have an SpO<sub>2</sub> accuracy of 70% to 100%  $\pm$  3.5 for adults during no motion conditions, however, since the monitor cannot display 1/2 digits, the accuracy shall be rounded to  $\pm$  4 digits.

<sup>6</sup>The SpO<sub>2</sub> accuracy during motion conditions is not specified for the LNOP<sup>®</sup>•Ear Sensors.

### 6.2.11.3 Nellcor SpO<sub>2</sub> Performance Requirements

Complies with the following Nellcor specifications:

046095 Rev. C. (MP304 OEM product specification)

068107 Rev. D/1 (NELL-3 OEM product specification)

Sensor Compatibility: Nellcor types: D-25/D-25L, R-15, N-25, I-20, D-20, RS-10, OxiCliq A, OxiCliq N, OxiCliq P, OxiCliq I, Oxiband A/N, Oxiband P/I, DS-100A, DY-S, Max-Fast

Measurement Technique: Nellcor proprietary algorithm.

<b>Saturation Accuracy</b>	<b>Patient Size</b>	<b>Range</b>
	Adult 70% to 100%,	± 2 digits
	Adult Below 70%,	unspecified
	Neonate 70% to 100%,	± 3 digits
	Neonate Below 70%,	unspecified

SpO<sub>2</sub> Response Time: 5 to 7 seconds averaging

### 6.2.11.4 Nellcor SpO<sub>2</sub> Pulse Rate Performance Requirements

Pulse Rate Range: 20 to 249 bpm

Pulse Rate Accuracy: ± 3 bpm

Update Rate: Every 2 seconds

## 6.2.12 CO<sub>2</sub>

The **Passport 2** is capable of providing CO<sub>2</sub> measurements from either an Oridion MediCO<sub>2</sub> capnography module, or an Oridion MiniMediCO<sub>2</sub> capnography module.

The CO<sub>2</sub> performance is in accordance with the requirements of EN 864 (MediCO<sub>2</sub>) or ISO 21647:2004 (MiniMediCO<sub>2</sub>).

### 6.2.12.1 MediCO<sub>2</sub> Microstream<sup>®</sup> (Only in monitors with serial numbers below TS10000.)

Range\*: 0 - 99 mmHg

Accuracy: The accuracy specification of the measured CO<sub>2</sub> partial pressure is according to the following table:

TIME	CO <sub>2</sub> CONCENTRATION*	ACCURACY**
0 - 20 min.	0 - 38mmHg	± 4 mmHg
	39 - 99 mmHg	± 12% Reading
20 min. and up	0 - 38 mmHg	± 2 mmHg
	39 - 99 mmHg	± 5% Reading + 0.08% for every 1 mmHg above 40 mmHg

\* At sea level (760 mmHg)

\*\* Accuracy applies for respiration rates of up to 80 RPM. For respiration rates above 80 RPM, accuracy complies with EN864 / ISO9918 (4 mmHg or ± 12% of reading whichever is greater) for EtCO<sub>2</sub> values exceeding 19 mmHg. To achieve the specified accuracies for respiration rates above 60 RPM an endotracheal tube adapter with low dead-space must be added in neonatal mode.

The accuracy specification is maintained to within 4% for the following gas mixtures (all values are in Vol. %)

CO <sub>2</sub>	N <sub>2</sub>	O <sub>2</sub>	N <sub>2</sub> O	H <sub>2</sub> O	ANESTHETIC AGENTS
0 to 13	0 to 97.5	0 to 100	0 to 80	Dry to Saturated	According to EN864

Above 80% O<sub>2</sub>, 1 mmHg has to be added to the upper tolerance of the accuracy specifications.

Sampling Rate: 50 ml/minute, ± 7.5 ml/min.

Auto Zero: ≤ 15 seconds Auto Zero occurs as required during warm up. Auto zero also occurs if the temperature changes by more than 8°C or the pressure changes by more than 5mmHg from the last zero.

Readings are calculated at BTPS: CO<sub>2</sub> = 0.97 x CO<sub>2</sub> (STPD).



Rise Time:	≤ 190 msec. to display 10 to 90% step change with a 5% CO <sub>2</sub> balance air test gas at 10 liters per minute flow through an airway adapter
Fall Time	≤ 190 m sec. to display 90 to 10% step change with a 5% CO <sub>2</sub> balance air test gas at a 10 liters per minute flow through an airway adapter.
Delay Time:	< 3 Seconds.

### 6.2.12.2 MiniMediCO<sub>2</sub> Microstream<sup>®</sup> (Only in monitors with serial number TS10000 and higher.)

Range: 0 - 99 mmHg

Accuracy specification of the measured CO<sub>2</sub> partial pressure is according to the following table (This testing is done according to ISO 21647 clauses 51.101.1 and 51.101.2.).

CO <sub>2</sub> PARTIAL PRESSURE *	ACCURACY**
0 - 38 mmHg	± 2 mmHg
39 - 99 mmHg	± (5% of reading + 0.08% for every 1 mmHg above 38 mmHg)

\* At sea level.

\*\* Accuracy applies for respiration rates of up to 80 RPM. For respiration rates above 80 RPM, accuracy is 4 mmHg or ± 12% of the reading, whichever is greater, for EtCO<sub>2</sub> values exceeding 18 mmHg. This is tested according to and is compliant with EN 864 and ISO 21647. To achieve the specified accuracies for respiration rates above 60 respirations/minute, the Microstream FilterLine H Set for Infant/Neonatal (p/n 006324) must be used. Above 55 degrees C module temperature, ± 1 mmHg or ± 2.5% (whichever is greater) has to be added to the tolerance of the accuracy specs.

Accuracy in the presence of interfering gases:

The accuracy specification is maintained to within 4% of the values indicated in the table above in the presence of interfering gases according to ISO 21647 clauses 51.101.3 and 101.1.

Flow Rate: 50 ml/min -7.5 + 15 ml/min, flow measured by volume.

Self Maintenance (SFM) Interval:

Self-Maintenance (SFM) is performed only during measurement mode. The module performs one or more of the following:

- Ambient pressure measurement
- Auto zero (AZ)
- Flow test

SFM is triggered under the following conditions:

- During the first hour after entering measurement mode, periodically for durations of typically 10 seconds at a rate which limits the total time consumed by SFMs to less than 2% of the time in which active measurements are taken. Following the first hour after entering measurement mode, periodically for durations of typically 10 seconds at a rate of at most once per hour.
- If a change of 8 °C from the last AZ is detected.
- If a pressure change of 20 mmHg relative to the last ambient pressure measurement (less than the purge threshold) for a period of 30 seconds is detected. The module will be able to detect a real change in the ambient pressure and a pressure change due to partial blockage of the FilterLine.

The module prevents the triggering of an SFM in the following situations:

- In case of purging until the end of this state.
- During a breath absence period which follows a valid breath.
- While waiting a minimum of 20 seconds for host SFM enable command. (After the 20-second opportunity given to the host to schedule the SFM passes, the module schedules the SFM according to a priority determined by current conditions).

System Response Time:	The system response time (with a standard-length FilterLine) which includes the delay time and rise time (10% to 90%) in response to a step change in the CO <sub>2</sub> concentration is 2.9 seconds typical.
Rise Time (Adult and Neonatal):	190 msec maximum
Delay Time:	2.7 seconds typical
Pump Calibration Interval:	No routine calibration is required. The module should initially be calibrated after 1200 operating hours, then once a year or after 4,000 operating hours, whichever comes first.

## 6.2.13 Physical Characteristics

Maximum Size:	11.9"W x 9.5"H x 7.4"D
Maximum Weight:	11.4 lbs without batteries 15.0 lbs with 2 Sealed Lead Acid batteries 13.0 lbs with 2 Lithium-Ion batteries

## 6.2.14 Printer

The printer is a two trace maximum thermal strip chart printer with integral paper spool. The number of traces are user selectable. The printer uses plain white thermal paper 5 cm wide and supports 5 paper speeds: 3.125, 6.25, 12.5, 25, and 50 mm/sec.

## 6.2.15 Comm-Port

Communication with external devices (i.e. VISA or Patient Net Central Station, Remote Display, Gas Module and Nurse Call System) is accomplished via the Comm-Port. The Comm-Port is permanently mounted in a recess on the under side of the monitor.

### 6.2.15.1 Physical Characteristics

Maximum Size: Has no impact on the size of the **Passport 2/Passport 2 LT**.

Maximum Weight: 0.5 lbs.

### 6.2.15.2 Communication Characteristics

The Comm Port supports the following connections:

- Remote VGA Display - Connection to a medical grade VGA monitor for remote repeater display P/N 0160-00-0022. The display mimics the main display (15 pin D-subminiature female connector).
- Nurse Call - The Nurse Call function interfaces to hospital nurse call systems. The connector is a 3-pin DIN connector. The monitor activates a relay, which resides in an interface cable P/N 0012-00-1277-02. The cable interfaces with "normal open" signaling systems with a minimum of 1,500VAC isolation.
- Serial Communication Channel Supports **Passport 2** to Visa (with Admit) protocol, PatientNet protocol, Mindray DS Improved ASCII Protocol (DIAP)<sup>1</sup>, Accutorr Communications Protocols<sup>2</sup> and Gas Module. The interface is proprietary.
- Ethernet Communications Port - Supports **Passport 2** interface to Panorama Central Station or to laser printer using 100 BASE-TX Ethernet.

<sup>1</sup>The **Passport 2** supports the DIAP (P/N 0070-00-0307) with the following exceptions:

- The NIBP elapsed time is set to "--" when the elapsed time is greater than 999 minutes.
- Though not specified in the protocol, the alarm limit values are at the same resolution as the parameter value. Example, temperature is 10X, therefore, the alarm limit values are also 10X.
- Baud rate is 9600 or 19200.

<sup>2</sup>The **Passport 2** supports the Accutorr Communication Protocol (P/N 0070-00-0304) with the following exceptions:

- Baud rate is 9600 or 1200.
- The "Show patient data" command fields not supported are:
  - "f" Status Byte 0
  - "g" Status Byte 1
  - "h" Status Byte 2
  - "l" Status Byte 3

- The bits of Status Byte 1 not supported are:
  - Bit 1, SpO<sub>2</sub> Uncalibrated
  - Bit 2, SpO<sub>2</sub> Alarm Overlapped
  - Bit 3, SpO<sub>2</sub> RAM Test Failure
  - Bit 4, SpO<sub>2</sub> ROM Test Failure
  - Bit 5, SpO<sub>2</sub> OFFSET Mismatch
  - Bit 6, SpO<sub>2</sub> FILTER Mismatch
  - Bit 7, SpO<sub>2</sub> System Test in Progress
- The bits of Status Byte 2 not supported are:
  - Bit 1, NIBP indicating Motion Artifact
  - Bit 2 through 7 not used

### 6.2.16 Normal Operating Noise

The SPL produced by the unit during normal operating conditions shall be 60 dBA at 1 meter when measured in accordance with ISO 3744. Maximum SPL shall be measured with no alarms sounding, but all internal mechanical devices (i.e., pumps) running.

## 6.2.17 Battery

The monitor will operate from AC Mains power with or without the internal batteries installed.

### 6.2.17.1 Sealed Lead Acid Battery (P/N 0146-00-0043)

Battery Type:	Sealed Lead Acid
Number of Batteries:	2 (the unit is capable of operation with one battery for the sole purpose of changing batteries while in the normal operating mode.)
Minimum Battery Run Time:	1 hour and 50 minutes from two fully charged new batteries at 25°C with 3 Lead or 5 Lead ECG, SpO <sub>2</sub> , no CO <sub>2</sub> , no printing, and the NIBP running at the 15 minute interval.
Battery Recharge Time:	16 hours maximum.
Charging Method:	Parallel and independent.
Time to Shutdown from Low Battery:	>10 minutes but < 20 minutes after indication, with 2 new, fully charged batteries with no CO <sub>2</sub> and printer.

### 6.2.17.2 Lithium-Ion Battery (P/N 0146-00-0069)

Battery Type:	Lithium-ion
Number of Batteries:	2 (the unit is capable of operation with one battery for the sole purpose of changing batteries while in the normal operating mode.)
Minimum Battery Run Time:	5 hours from two fully charged new batteries at 25°C with 3 Lead or 5 Lead ECG, SpO <sub>2</sub> , no CO <sub>2</sub> , no printing, and the NIBP running at the 15 minute interval.
Battery Recharge Time:	5 hours maximum.
Charging Method:	Parallel and independent.
Time to Shutdown from Low Battery:	>10 minutes but < 20 minutes after indication, with 2 new, fully charged batteries with no CO <sub>2</sub> and printer.

### 6.2.18 AC Power

- 100 – 240 VAC (+/-10%), 50 or 60 Hz ( $\pm 3$  Hz)
- 1.2 – 0.7 Amps

### 6.2.19 Real Time Clock

Display Resolution: 1 minute

Accuracy:  $\pm 1$  minute/month (30 days) @  $21 \pm 3^\circ\text{C}$ .

Clock Display Format: 12 or 24 hour, user selectable

The Real Time Clock keeps time whether the rest of the system has power or not. A dedicated battery provides standby power for the clock circuit.

### 6.2.20 Power Selection

The Monitor auto-selects its power source from those available. The monitor uses the following priority in choosing the power source:

1. AC Mains Power
2. External DC from base station
3. Internal battery power

### 6.2.21 Fan Control

- The cooling fan is ON when the unit is powered from external power.
- The cooling fan is OFF when the unit is powered from the internal batteries.

### 6.2.22 Trend Storage

- The **Passport 2** monitor is capable of storing, in non-volatile memory, up to 120 trend values for each parameter and up to 6 minutes of OXY CRG data.
- With the addition of the Extended Trend Option (P/N 0996-00-0052-01), the **Passport 2** is capable of storing up to 500 trend values for each parameter, and up to 12 hours of OXY CRG data.

### 6.2.23 Transferring Monitor Default Settings

When installing several **Passport 2/Passport 2 LT** monitors and identical display settings and alarm settings are desired on each, a "Transfer Card" (P/N 0996-00-0051-01) can be used to copy the settings from monitor to monitor.

1. Insert the Transfer Card into the PCM2 slot on the right side of the source monitor.
2. Access the Functions menu, and select "Copy monitor defaults to card" from the menu. A status message will report completion of the transfer.
3. Remove the card and insert it into the PCM2 slot of the receiving monitor.
4. Enter Installation Mode on the receiving monitor (Press and hold the **DISCHARGE** key during power-up.), and select "Copy monitor defaults from card". A status message will report completion of the transfer.
5. Select "Save Current" and power-cycle the receiving monitor to enter normal monitoring mode.

### 6.2.24 Installation and Use of "Extended Trend" feature

- This feature is added to the **Passport 2/Passport 2 LT** by inserting the "Extended Trend" card (P/N 0996-00-0052-01) into slot PCM1 on the right side of the monitor. The card is to be inserted before monitor power-up, and never removed during monitor operation. In order to guard against accidental removal, the card slot is designed so that a tool is required to eject the card after insertion.
- The "Extended Trend" feature is automatically enabled when the unit is powered-up following card insertion.

**NOTE:**      **The Extended trend card must be removed prior to using the 12-Lead ECG features.**

### 6.2.25 Display

Size:	10.4" (diagonal) active matrix TFT
Resolution:	640 x 480 pixels
Sweep Speeds:	3.125 mm/, 6.25 mm/s, 12.5 mm/s, 25 mm/s, 50 mm/s

## 6.3 Environmental Conditions

### 6.3.1 Passport 2/Passport 2 LT

Transport and Storage Temperature:	-20°C to +60°C
Transport and Storage Humidity:	10 to 95%, Non-condensing
Transport and Storage Altitude:	-1250 to 9,889 feet ASL 1060hPa to 700 hPa 795 mmHg to 525 mmHg
Operating Temperature:	5°C to 40°C
Operating Humidity:	15% to 95%, maximum, non-condensing
Operating Altitude:	-1250 to 9,889 feet ASL 1060 hPa to 700 hPa 795mmHg to 525 mmHg
Gas Module II/SE Operating Humidity:	10 to 95%RH, non-condensing
Shipping:	ISTA shipping procedure 1A
Shock:	15g, 11 msec, half sine shock pulse
Vibration:	FDA Reviewer Guidance for Pre-market Notification Submission, November 1993, paragraphs n4ii and n4iii.
Drop:	ECRI PB-296 892 Section AIII 3.3 for Class 3 devices.
Impact:	ECRI PB-296 892, Section AIII 3.2 for Class 3 devices.
Spillage and Ingress of Fluids:	Non-protected Equipment (IPX0) as specified in IEC 60529.
Sound Pressure Level:	≥ 70 dBA but ≤ 85 dBA for Priority 1 and Priority 2 alarms per EN 475.



## 6.3.2 Gas Module 3

Transport and Storage Temperature:	-40 °C to +70 °C
Transport and Storage Humidity:	5 to 100%, condensing <sup>1</sup>
Operating Temperature:	10 °C to 40 °C
Operating Humidity:	10 to 95% RH, non-condensing (in Airway: 0-100% RH, condensing)
Operating Altitude:	Sea Level to 8,000 feet
Shipping:	ISTA shipping procedure 2A
Shock:	IEC 60068-2-27 peak acceleration: 150 m/s <sup>2</sup> (15.3 g); duration: 11 ms; pulse shape: half-sine; number of shocks: 3 shocks per direction per axis (18 total).
Vibration:	IEC 60068-2-64
Drop:	IEC 60068-2-32
Spillage and Ingress of Fluids:	Non-protected Equipment (IPX0) as specified in IEC 60529.

<sup>1</sup> After storage in a condensing atmosphere, the unit shall, before use, be kept for more than 24 hr. in an environment equivalent to the operating atmosphere.

**CAUTION: Gas Module 3 must be moisture protected whenever transported. This can be done with a protective plastic bag in which water-absorbing materials (e.g. silica gel) have been included.**

## 6.4 Agency Compliance

### 6.4.1 Passport 2/Passport 2 LT

The **Passport 2/Passport 2 LT** was designed to comply with the following industry standards:

- EN 60601-1
- UL 60601-1
- CSA Standard C22.2 No. 601.1M90
- EN 60601-1-1/IEC 60601-1-1
- EN 60601-1-4/IEC 60601-1-4
- EN 60601-2-27/IEC 60601-2-27
- EN 60601-2-30/IEC 60601-2-30
- EN 60601-0-25/IEC 60601-2-25
- EN 60601-2-49/IEC 60601-2-49

The View 12™ ECG Analysis Module complies with AAMI EC 11 for Diagnostic Electrocardiographic Devices.

The **Passport 2/Passport 2 LT** has been certified by CSA.

The **Passport 2/Passport 2 LT** has been tested for functionality following ESU (Electrosurgery Unit Interference) energy exposure as described in the draft Amendment A1 to IEC 60601-2-25.

### 6.4.2 Gas Module II and Gas Module SE

The **Gas Module II and Gas Module SE** were designed to comply with the following industry standards:

- EN 60601-1/IEC 60601-1
- UL 60601-1
- CSA Standard C22.2 No. 601.1M90

The **Gas Module II and Gas Module SE** have been certified by CSA.

### 6.4.3 Gas Module 3

The **Gas Module 3** was designed to comply with the following industry standards:

- EN 60601-1/IEC 60601-1
- UL 60601-1
- CSA Standard C22.2 No. 601.1M90
- EN 60601-1-1/IEC 60601-1-1
- EN 60601-1-4/IEC 60601-1-4
- ISO 21647

The **Gas Module 3** has been certified by CSA.

## 6.5 Electromagnetic Capability

### 6.5.1 Passport 2/Passport 2 LT

The **Passport 2/Passport 2 LT** meets the requirements of IEC 60601-1-2/EN 60601-1-2.

**NOTE:** The **Passport 2/Passport 2 LT** needs special precautions regarding EMC and needs to be installed and put into service according to the EMC information provided below.

**NOTE:** Portable and mobile RF communications equipment can affect the **Passport 2/Passport 2 LT**. See tables 6-1 through 6-4 that follow.

**TABLE 6-1**

#### **GUIDANCE AND MINDRAY DS USA INC. DECLARATION - ELECTROMAGNETIC EMISSIONS**

The **Passport 2/Passport 2 LT** is intended for use in the electromagnetic environment specified below. The customer or the user of the **Passport 2/Passport 2 LT** should assure that it is used in such an environment.

<b>EMISSIONS TEST</b>	<b>COMPLIANCE</b>	<b>ELECTROMAGNETIC ENVIRONMENT - GUIDANCE</b>
RF emissions CISPR 11	Group 1	The <b>Passport 2/Passport 2 LT</b> uses RF energy only for its internal function. Therefore, its RF emissions are very low and are not likely to cause any interference in nearby electronic equipment.
RF emissions CISPR 11	Class A	The <b>Passport 2/Passport 2 LT</b> is suitable for use in all establishments other than domestic establishments and those directly connected to the public low-voltage power supply network that supplies buildings used for domestic purposes
Harmonic emissions IEC 61000-3-2	Class A	
Voltage fluctuations/ Flicker emissions IEC 61000-3-3	Complies	

TABLE 6-2

**GUIDANCE AND MINDRAY DS USA INC. DECLARATION - ELECTROMAGNETIC IMMUNITY**

The **Passport 2/Passport 2 LT** is intended for use in the electromagnetic environment specified below. The customer or the user of the **Passport 2/Passport 2 LT** should assure that it is used in such an environment.

<b>IMMUNITY TEST</b>	<b>IEC 60601 TEST LEVEL</b>	<b>COMPLIANCE LEVEL</b>	<b>ELECTROMAGNETIC ENVIRONMENT - GUIDANCE</b>
Electrostatic discharge (ESD) IEC 61000-4-2	±6 kV contact ±8 kV air	±6 kV contact ±8 kV air	Floors should be wood, concrete or ceramic tile. If floors are covered with synthetic material, the relative humidity should be at least 30%.
Electrical fast transient/burst IEC 61000-4-4	±2 kV for power supply lines ±1 kV for input/output lines	±2 kV for power supply lines ±1 kV for input/output lines	Mains power quality should be that of a typical commercial or hospital environment.
Surge IEC 61000-4-5	±1 kV differential mode ±2 kV common mode	±1 kV differential mode ±2 kV common mode	Mains power quality should be that of a typical commercial or hospital environment.
Voltage dips, short interruptions and voltage variations on power supply input lines IEC 61000-4-11	<5% $U_T$ (>95% dip in $U_T$ ) for 0.5 cycle	<5% $U_T$ (>95% dip in $U_T$ ) for 0.5 cycle	Mains power quality should be that of a typical commercial or hospital environment. If the user of the <b>Passport 2/Passport 2 LT</b> requires continued operation during power mains interruptions, it is recommended that the <b>Passport 2/Passport 2 LT</b> be powered from an uninterruptible power supply or a battery.
	40% $U_T$ (60% dip in $U_T$ ) for 5 cycles	40% $U_T$ (60% dip in $U_T$ ) for 5 cycles	
	70% $U_T$ (30% dip in $U_T$ ) for 25 cycles	70% $U_T$ (30% dip in $U_T$ ) for 25 cycles	
	<5% $U_T$ (>95% dip in $U_T$ ) for 5 sec	<5% $U_T$ (>95% dip in $U_T$ ) for 5 sec	
Power frequency (50/60 Hz) magnetic field IEC 61000-4-8	3 A/m	3 A/m	Power frequency magnetic fields should be at levels characteristic of a typical location in a typical commercial or hospital environment.

$U_T$  is the A.C. mains voltage prior to application of the test level.

TABLE 6-3

**GUIDANCE AND MINDRAY DS USA INC. DECLARATION - ELECTROMAGNETIC IMMUNITY**

The **Passport 2/Passport 2 LT** is intended for use in the electromagnetic environment specified below. The customer or the user of the **Passport 2/Passport 2 LT** should assure that it is used in such an environment.

IMMUNITY TEST	IEC 60601 TEST LEVEL	COMPLIANCE LEVEL	ELECTROMAGNETIC ENVIRONMENT - GUIDANCE
			Portable and mobile RF communications equipment should be used no closer to any part of the <b>Passport 2/Passport 2 LT</b> , including cables, than the recommended separation distance calculated from the equation applicable to the frequency of the transmitter.
			<b>Recommended separation distance</b>
Conducted RF IEC 61000-4-6	3 Vrms 150 kHz to 80 MHz	3 Vrms	$d = 1.2 \times \sqrt{P}$
Radiated RF IEC 61000-4-3	3 V/m 80 MHz to 2.5 GHz	3 V/m	$d = 1.2 \times \sqrt{P}$ 80 MHz to 800 MHz $d = 2.3 \times \sqrt{P}$ 800 MHz to 2.5 GHz
			where $P$ is the maximum output power rating of the transmitter in watts (W) according to the transmitter manufacturer and $d$ is the recommended separation distance in meters (m).
			Field strengths from fixed RF transmitters, as determined by an electromagnetic site survey, <sup>a</sup> should be less than the compliance level in each frequency range. <sup>b</sup>
			Interference may occur in the vicinity of equipment marked with the following symbol: 

**NOTE:** At 80 MHz and 800 MHz, the higher frequency range applies.

**NOTE:** These guidelines may not apply in all situations. Electromagnetic propagation is affected by absorption and reflection from structures, objects and people.

*a* Field strengths from fixed transmitters, such as base stations for radio (cellular/cordless) telephones and land mobile radios, amateur radio, AM and FM radio broadcast and TV broadcast cannot be predicted theoretically with accuracy. To assess the electromagnetic environment due to fixed RF transmitters, an electromagnetic site survey should be considered. If the measured field strength in the location in which the Passport 2/Passport 2 LT is used exceeds the applicable RF compliance level above, the Passport 2/Passport 2 LT should be observed to verify normal operation. If abnormal performance is observed, additional measures may be necessary, such as reorienting or relocating the Passport 2/Passport 2 LT.

*b* Over the frequency range 150 kHz to 80 MHz, field strengths should be less than 3 V/m.

**TABLE 6-4****RECOMMENDED SEPARATION DISTANCES BETWEEN PORTABLE AND MOBILE RF COMMUNICATIONS EQUIPMENT AND THE PASSPORT 2/PASSPORT 2 LT**

The **Passport 2/Passport 2 LT** is intended for use in an electromagnetic environment in which radiated RF disturbances are controlled. The customer or the user of the **Passport 2/Passport 2 LT** can help prevent electromagnetic interference by maintaining a minimum distance between portable and mobile RF communications equipment (transmitters) and the **Passport 2/Passport 2 LT** as recommended below, according to the maximum output power of the communications equipment.

RATED MAXIMUM OUTPUT POWER (P) OF TRANSMITTER IN WATTS (W)	SEPARATION DISTANCE (d) IN METERS (m) ACCORDING TO FREQUENCY OF TRANSMITTER		
	150 kHz to 80 MHz	80 MHz to 800 MHz	800 MHz to 2.5 GHz
	$d = 1.2 \times \sqrt{P}$	$d = 1.2 \times \sqrt{P}$	$d = 2.3 \times \sqrt{P}$
0.01	0.12	0.12	0.23
0.1	0.38	0.38	0.73
1	1.2	1.2	2.3
10	3.8	3.8	7.3
100	12	12	23

For transmitters rated at a maximum output power not listed above, the recommended separation distance  $d$  in meters (m) can be determined using the equation applicable to the frequency of the transmitter, where  $P$  is the maximum output power rating of the transmitter in watts (W) according to the transmitter manufacturer.

**NOTE:** At 80 MHz and 800 MHz, the separation distance for the higher frequency range applies.

**NOTE:** These guidelines may not apply in all situations. Electromagnetic propagation is affected by absorption and reflection from structures, objects and people.

## 6.5.2 Gas Module SE and Gas Module 3

The **Gas Module SE and Gas Module 3** meet the requirements of IEC 60601-1-2/EN 60601-1-2.

**NOTE:** The **Gas Module SE and Gas Module 3** need special precautions regarding EMC and need to be installed and put into service according to the EMC information provided below.

**NOTE:** Portable and mobile RF communications equipment can affect the **Gas Module SE and Gas Module 3**. See tables 6-5 through 6-8 that follow.

**TABLE 6-5**

**GUIDANCE AND MINDRAY DS USA INC. DECLARATION - ELECTROMAGNETIC EMISSIONS**

The **Gas Module SE and Gas Module 3** are intended for use in the electromagnetic environment specified below. The customer or the user of the **Gas Module SE or Gas Module 3** should assure that they are used in such an environment.

<b>EMISSIONS TEST</b>	<b>COMPLIANCE</b>	<b>ELECTROMAGNETIC ENVIRONMENT - GUIDANCE</b>
RF emissions CISPR 11	Group 1	The <b>Gas Module SE and Gas Module 3</b> use RF energy only for their internal function. Therefore, their RF emissions are very low and are not likely to cause any interference in nearby electronic equipment.
RF emissions CISPR 11	Class A	The <b>Gas Module SE and Gas Module 3</b> are suitable for use in all establishments other than domestic establishments and those directly connected to the public low-voltage power supply network that supplies buildings used for domestic purposes.
Harmonic emissions IEC 61000-3-2	Class A	
Voltage fluctuations/ Flicker emissions IEC 61000-3-3	Complies	

**TABLE 6-6****GUIDANCE AND MINDRAY DS USA INC. DECLARATION - ELECTROMAGNETIC IMMUNITY**

The **Gas Module SE and Gas Module 3** are intended for use in the electromagnetic environment specified below. The customer or the user of the **Gas Module SE or Gas Module 3** should assure that they are used in such an environment.

<b>IMMUNITY TEST</b>	<b>IEC 60601 TEST LEVEL</b>	<b>COMPLIANCE LEVEL</b>	<b>ELECTROMAGNETIC ENVIRONMENT - GUIDANCE</b>
Electrostatic discharge (ESD) IEC 61000-4-2	±6 kV contact ±8 kV air	±6 kV contact ±8 kV air	Floors should be wood, concrete or ceramic tile. If floors are covered with synthetic material, the relative humidity should be at least 30%.
Electrical fast transient/burst IEC 61000-4-4	±2 kV for power supply lines ±1 kV for input/output lines	±2 kV for power supply lines ±1 kV for input/output lines	Mains power quality should be that of a typical commercial or hospital environment.
Surge IEC 61000-4-5	±1 kV differential mode ±2 kV common mode	±1 kV differential mode ±2 kV common mode	Mains power quality should be that of a typical commercial or hospital environment.
Voltage dips, short interruptions and voltage variations on power supply input lines IEC 61000-4-11	<5% $U_T$ (>95% dip in $U_T$ ) for 0.5 cycle	<5% $U_T$ (>95% dip in $U_T$ ) for 0.5 cycle	Mains power quality should be that of a typical commercial or hospital environment. If the user of the <b>Gas Module SE or Gas Module 3</b> requires continued operation during power mains interruptions, it is recommended that the <b>Gas Module SE or Gas Module 3</b> be powered from an uninterruptible power supply or a battery.
	40% $U_T$ (60% dip in $U_T$ ) for 5 cycles	40% $U_T$ (60% dip in $U_T$ ) for 5 cycles	
	70% $U_T$ (30% dip in $U_T$ ) for 25 cycles	70% $U_T$ (30% dip in $U_T$ ) for 25 cycles	
	<5% $U_T$ (>95% dip in $U_T$ ) for 5 sec	<5% $U_T$ (>95% dip in $U_T$ ) for 5 sec	
Power frequency (50/60 Hz) magnetic field IEC 61000-4-8	3 A/m	3 A/m	Power frequency magnetic fields should be at levels characteristic of a typical location in a typical commercial or hospital environment.

$U_T$  is the A.C. mains voltage prior to application of the test level.



**TABLE 6-7**

**GUIDANCE AND MINDRAY DS USA INC. DECLARATION - ELECTROMAGNETIC IMMUNITY**

The **Gas Module SE and Gas Module 3** are intended for use in the electromagnetic environment specified below. The customer or the user of the **Gas Module SE or Gas Module 3** should assure that they are used in such an environment.

IMMUNITY TEST	IEC 60601 TEST LEVEL	COMPLIANCE LEVEL	ELECTROMAGNETIC ENVIRONMENT - GUIDANCE
Conducted RF IEC 61000-4-6	3 Vrms 150 kHz to 80 MHz	3 Vrms	Portable and mobile RF communications equipment should be used no closer to any part of the <b>Gas Module SE or Gas Module 3</b> , including cables, than the recommended separation distance calculated from the equation applicable to the frequency of the transmitter.  <b>Recommended separation distance</b> $d = 1.2 \times \sqrt{P}$
Radiated RF IEC 61000-4-3	3 V/m 80 MHz to 2.5 GHz	3 V/m	$d = 1.2 \times \sqrt{P}$ 80 MHz to 800 MHz $d = 2.3 \times \sqrt{P}$ 800 MHz to 2.5 GHz where $P$ is the maximum output power rating of the transmitter in watts (W) according to the transmitter manufacturer and $d$ is the recommended separation distance in meters (m).  Field strengths from fixed RF transmitters, as determined by an electromagnetic site survey, <sup>a</sup> should be less than the compliance level in each frequency range. <sup>b</sup>
			Interference may occur in the vicinity of equipment marked with the following symbol: 

**NOTE:** At 80 MHz and 800 MHz, the higher frequency range applies.

**NOTE:** These guidelines may not apply in all situations. Electromagnetic propagation is affected by absorption and reflection from structures, objects and people.

- a* Field strengths from fixed transmitters, such as base stations for radio (cellular/cordless) telephones and land mobile radios, amateur radio, AM and FM radio broadcast and TV broadcast cannot be predicted theoretically with accuracy. To assess the electromagnetic environment due to fixed RF transmitters, an electromagnetic site survey should be considered. If the measured field strength in the location in which the Gas Module SE or Gas Module 3 are used exceeds the applicable RF compliance level above, the Gas Module SE or Gas Module 3 should be observed to verify normal operation. If abnormal performance is observed, additional measures may be necessary, such as reorienting or relocating the Gas Module SE or Gas Module 3.
- b* Over the frequency range 150 kHz to 80 MHz, field strengths should be less than 3 V/m.

**TABLE 6-8****RECOMMENDED SEPARATION DISTANCES BETWEEN PORTABLE AND MOBILE RF COMMUNICATIONS EQUIPMENT AND THE GAS MODULE SE OR GAS MODULE 3**

The **Gas Module SE and Gas Module 3** are intended for use in an electromagnetic environment in which radiated RF disturbances are controlled. The customer or the user of the **Gas Module SE or Gas Module 3** can help prevent electromagnetic interference by maintaining a minimum distance between portable and mobile RF communications equipment (transmitters) and the **Gas Module SE or Gas Module 3** as recommended below, according to the maximum output power of the communications equipment.

RATED MAXIMUM OUTPUT POWER (P) OF TRANSMITTER IN WATTS (W)	SEPARATION DISTANCE (d) IN METERS (m) ACCORDING TO FREQUENCY OF TRANSMITTER		
	150 kHz to 80 MHz	80 MHz to 800 MHz	800 MHz to 2.5 GHz
	$d = 1.2 \times \sqrt{P}$	$d = 1.2 \times \sqrt{P}$	$d = 2.3 \times \sqrt{P}$
0.01	0.12	0.12	0.23
0.1	0.38	0.38	0.73
1	1.2	1.2	2.3
10	3.8	3.8	7.3
100	12	12	23

For transmitters rated at a maximum output power not listed above, the recommended separation distance  $d$  in meters (m) can be determined using the equation applicable to the frequency of the transmitter, where  $P$  is the maximum output power rating of the transmitter in watts (W) according to the transmitter manufacturer.

**NOTE:** At 80 MHz and 800 MHz, the separation distance for the higher frequency range applies.

**NOTE:** These guidelines may not apply in all situations. Electromagnetic propagation is affected by absorption and reflection from structures, objects and people.

## 6.6 Indirect Blood Pressure Measurements And Associated Errors

Place the patient in a supine position to obtain true physiological pressure. If the cuff is not at the patient's heart level, the pressure values obtained will not reflect the true physiological pressure. Instead, the readings will be decreased by 1.86 mmHg for every inch the cuff is placed above the heart level and increased by 1.86 mmHg for every inch the cuff is placed below the heart level. This effect is due to hydrostatic pressure.

Blood has weight and it is this weight that influences these blood pressure readings. The value of the weight of blood depends on where the measurement is taken with respect to the heart. When the patient is supine, on a flat surface, the arm is near enough to the heart level so no adjustment of the NIBP readings will be necessary.

## 6.7 Precautions While Making Automatically Cycled Blood Pressure Measurements

Reports have been made of nerve injury occurring from automatically cycled blood pressure measurements. The following practices are recommended when making automatically cycled blood pressure measurements:

- Position and support the limb in such a way as to minimize stretching of and weight exertion on affected nerves.
- Avoid cuff placement that applies pressure on the ulnar nerve. Cuff tubing should not exit the cuff over the course of the ulnar nerve at the elbow.
- Select a measurement interval that provides adequate venous drainage during cuff deflation.
- Periodically inspect the limb bearing the cuff in order to detect venostasis.

### 6.7.1 Cuff Size

Using a narrow cuff gives erroneously high pressure readings. If a standard cuff is applied to an obese patient or a patient with large biceps, the extra tissue and fat will dissipate the applied pressure, requiring an additional pressure increase to collapse the artery. On the other hand, over-wrapping a slender arm gives erroneously low pressure readings. Too much force per unit area is exerted. This requires less pressure to collapse the artery.

### 6.7.2 Other Factors

An accurate determination of blood pressure by the **Passport 2/Passport 2 LT** can be difficult if cardiac rhythm is very irregular. Irregular cardiac rhythm changes the stroke volume from beat to beat. This changing stroke volume may increase the time it takes the **Passport 2/Passport 2 LT**, to make a measurement. The **Passport 2/Passport 2 LT** makes up to four successive attempts to obtain a measurement. If a measurement cannot be made after four tries, the numeric displays are zeroed.

## 6.8 User Verification Of Passport 2 Measurements

Regular service to blood pressure equipment will help insure accurate measurements. Consult your service manual for appropriate information.

If you question the accuracy of the **Passport 2/Passport 2 LT** check it (the **Passport 2/Passport 2 LT**) with a manometer. See the Calibration Section of the Passport Service Manual.

Auscultatory verification can be made at the same time the **Passport 2/Passport 2 LT** is taking a measurement. Apply a bell stethoscope over the brachial artery. Do not allow the stethoscope to touch either the patient's clothing or the pressure cuff.

## 6.9 Newborn NIBP Technique

Newborn patients present unique obstacles to NIBP measurement. Their vital signs can change from moment to moment, and their tiny physiological signals are very prone to noise interference. The following suggestions will help you to obtain the best possible NIBP measurement.

- Try to measure infants when they are calm. A kicking/crying baby may disturb or jiggle the cuff, causing noise within the system and, as a result, yielding unstable blood pressure readings. If necessary, hold the cuffed limb steady, but do not impede circulation; do not hold onto the cuff and do not “pat” the cuffed limb to comfort the child.
- Try the calf. Irritable newborns will react to the cuff pressure but may tolerate the calf better than the arm. Place the cuff just above the ankle.
- Use the correct size cuff. Mindray DS offers Newborn and Infant size cuffs. When applying, verify the cuff’s “Index” line falls between the “Range” lines.
- Try disposable cuffs. Disposable cuffs are more pliant than the reusable ones. They generally fit really tiny infants better.
- Place the cuff lightly. If the cuff is too snug, it won’t work properly. On infants, you should be able to easily move the cuff over the limb.

Remember NIBP cannot be taken under all conditions. Even manual methods, employing a sphygmomanometer and stethoscope, will not work on unstable or active patients.

## 6.10 How To Get Help

Mindray DS maintains a network of service representatives and factory-trained distributors. Prior to requesting service, perform a complete operational check of the instrument to verify proper control settings. If operational problems continue to exist, contact the Mindray DS Service Department at (800) 288-2121 or (201) 995-8116 for assistance in determining the nearest field service location.

Please include the instrument model number, the serial number, and a description of the problem with all requests for service.

Any questions regarding the warranty should be directed to the nearest Mindray DS location. A list of international offices, along with their phone numbers, is provided at the end of this manual.

**NOTE:** Upon request, Mindray DS will provide circuit diagrams, component part lists, descriptions, calibration instructions, or other information which will assist the user’s appropriately qualified technical personnel to repair those parts of the Mindray DS equipment which are designated by Mindray DS as repairable.

## 6.11 Warranty

### 6.11.1 USA, Canada, Mexico, and Puerto Rico

Mindray DS USA Inc. warrants that its products will be free from defects in workmanship and materials for a period of one (1) year from the date of purchase except that disposable or one-time use products are warranted to be free from defects in workmanship and materials up to a date one year from the date of purchase or the date of first use, whichever is sooner. This warranty does not cover consumable items such as, but not limited to, batteries, external cables, sensors, cuffs, hoses, or mounts.

Mindray DS USA Inc. shall not be liable for any incidental, special, or consequential loss, damage, or expense directly or indirectly arising from the use of its products, liability under this warranty and the buyer's exclusive remedy under this warranty is limited to servicing or replacing at Mindray DS Corp's option at the factory or at an authorized Mindray DS Distributor, any product which shall under normal use and service appear to the Company to have been defective in material or workmanship.

No agent, employee, or representative of Mindray DS USA Inc. has any authority to bind Mindray DS USA Inc. to any affirmation, representation, or warranty concerning its products, and any affirmation, representation or warranty made by any agent, employee, or representative shall not be enforceable by buyer.

This warranty is expressly in lieu of any other express or implied warranties, including any implied warranty or merchantability or fitness, and of any other obligation on the part of the seller.

Damage to any product or parts through misuse, neglect, accident, or by affixing any non-standard accessory attachments or by any customer modification voids this warranty. Mindray DS USA Inc. makes no warranty whatever in regard to trade accessories, such being subject to the warranty of their respective manufacturers.

A condition of this warranty is that this equipment or any accessories which are claimed to be defective be returned when authorized by Mindray DS, freight prepaid to Mindray DS USA Inc., Mahwah, New Jersey 07430. Mindray DS USA Inc. shall not have any responsibility in the event of loss or damage in transit.

Calibration may be performed without the need to disassemble the instrument. It is the responsibility of the purchaser to perform calibration as necessary, in accordance with the instructions provided in this manual.

## 6.12 Mindray DS's Responsibility

Mindray DS is responsible for the effects on safety, reliability and performance of the equipment only if:

- a.** assembly operations, extensions, readjustments, modifications or repairs are carried out by persons authorized by Mindray DS; and
- b.** the electrical installation of the relevant room complies with the appropriate requirements; and
- c.** the equipment is used in accordance with the instructions for use.

## 6.13 Extended Warranty

Mindray DS USA Inc. warrants that components within the monitor unit will be free from defects in workmanship and materials for the number of years shown on the Mindray DS invoice. Under this extended warranty, Mindray DS USA Inc. will repair or replace any defective component at no charge for labor and/or materials. This extended warranty does not cover consumable items such as, but not limited to batteries, displays, external cables and sensors.

Recommended preventative maintenance, as prescribed in the service manual, is the responsibility of the user, and is not covered by this warranty.

Except as otherwise provided herein, the terms, conditions and limitations of Mindray DS's standard warranty shall remain in effect.



---

*Mindray DS USA, Inc. • 800 MacArthur Boulevard • Mahwah, NJ 07430 • USA •  
Dom. Customer Service: 1.800.288.2121 • Intl. Customer Service: +1.201.995.8000 •  
Dom. Fax: 1.800.926.4275 • Intl. Fax: +1.201.995.8680 • www.mindray.com*

*Mindray Medical Netherlands B.V. • P.O. Box 26 • 3870 CA Hoevelaken • The Netherlands •  
Tel: +31 33 25 44 911 • Fax: +31 33 25 37 621*

*Mindray (UK) Limited • 3 Percy Road • St. John's Park • Huntingdon • Cambridgeshire PE29 6SZ •  
United Kingdom • Tel: 01480 416840 • Fax: 01480 436588*

*Mindray Medical France SARL • Europarc Créteil • 123, Chemin des Bassins •  
94035 Créteil Cedex • France • Tel: (0)1.45.13.91.50 • Fax: (0)1.45.13.91.51*

*Mindray Medical German GmbH • Zwischen den Bächen 4 • 64625 Bensheim • Germany •  
Tel: +49.6251.17524-0 • Fax: +49.6251.17524-20*

*Mindray Medical International Ltd. • 2813 Office Tower, Convention Plaza • No 1 Harbour Road •  
Wanchai • Hong Kong • Tel: +852 2793 5596 • Fax: +852 2344 8824*